

# Clamp-on Power Meters

Models CW120,CW121 Model CW140 Model AP140E

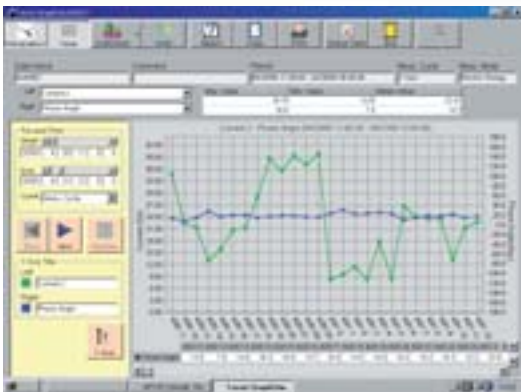

**Power Quality**  
**CW140** CE UL



AP140E Data Analysis Program

**Energy Saving**  
**CW120** CE UL

**Support for a variety of connection types**

- CW120 covers single-phase 2-wire to three-phase 3-wire
- CW121 and CW140 covers single-phase 2-wire to three-phase 4-wire

**Sophisticated data management software (Model AP140E)**

- On line measurement, customizing trend graph and making report

**Current clamps in a range of sizes (small to large) for a variety application**

- 50A, 200A, 500A, 700A 1000-3000A current clamps

# Comparison with CW Clamp-on Power Meters and wide range of applications

CW120 / CW140

## Model CW120 Clamp-on Power Meter



**Maintenance and long term monitoring of the power consumption in switch board and electric facilities**

**Long term power monitoring up to 12 months**  
Monitoring data are stored in an ATA flash memory card mounted in CW120.

**Compact and light weight body**  
117×161×51mm, 600g

**Support 3-phase 4-wire system, CAT III 600V**

**Various communication functions**  
RS485 or RS232 communication

**Protocol**  
MODBUS, PC-link, Power Monitor and proprietary.  
All parameters for CW120 can be set from a setting tool on PC.

## Model CW140 Clamp-on Power Meter



**Demand Monitoring of the power consumption for electric facilities**

CW140 has Demand Monitoring function and Logging function.

**Measure 1<sup>st</sup> trough 13<sup>th</sup> order Harmonics on a power source**

Harmonics Analysis becomes important to maintain the power source in good quality.

**Various Power measurement function**

From single-phase 2-wire to 3-phase 4-wire system. Simultaneous measurement of two set of 3-phase 3 wire system.

**Multi-language, large size LCD screen**  
5.9 inches, 320×240pixels

**Useful Accessories**

Printer, FDD unit,  
Three way power supplies (Dry cell, Rechargeable battery, External power 100 to 240V AC)

## Details for Models CW120 and CW140

Items		CW120/CW121	CW140
Measurement Mode	Input system	Single-phase 2-wire to 3-phase 4-wire	Single-phase 2-wire to 3-phase 4-wire
	Instant mode	(Up to 3 phase 3 wire for CW120)	
	Electric Energy mode	Available	Available
	Demand mode	Not available	Available
Display	Screen	Segmented LCD with backlight	5.9 inches Graphical LCD, 320×240pixels with backlight
	Language	Not available (Data, Symbols)	English, French, Germany, Italian, Spanish, Japanese
Communication	Interface	RS232, RS485	RS232
	Protocol	MODBUS, PC-link, Power-Monitor, Proprietary	Proprietary
	Monitoring by AP140E	Available	Available
Power supply		100 to 240V AC, Supply the power from input.	Dry cell, Rechargeable battery, 100 to 240V AC
Size (W×H×D)		117×161×51mm	206×184×65mm
Weight		600g	1.2kg (without dry cell or battery)

Power data

Energy conservation data

Conserving limited energy resources, cutting down on CO<sub>2</sub> emissions, and preventing global warming are now important global environmental issues. One important aspect of these issues is conserving electricity. By providing data to help you understand how you currently use energy, the CW Series can play an important role in creating energy conservation programs. The CW Series provide the data you need to find ways to conserve energy.

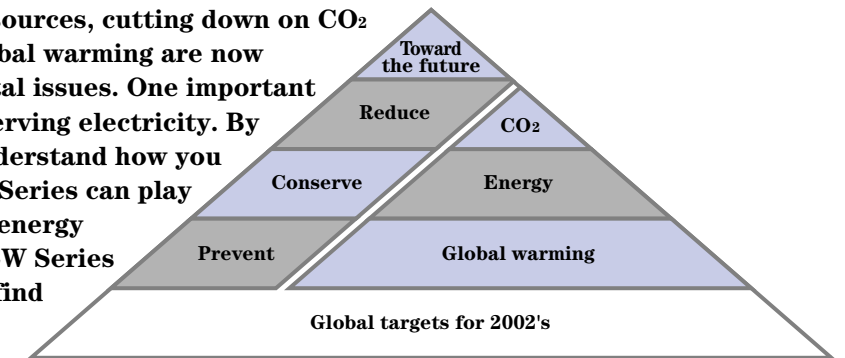

## Energy conservation applications

- ◆ Data obtained in electric energy mode and demand mode are based for energy conservation applications.
- ◆ Measurement data are saved in CSV format, and can be used to create graphs, etc. using off-the-shelf spreadsheet programs.

## A wide range of applications Instant mode, electric energy mode, demand mode, harmonics mode

### •Factory energy conservation data

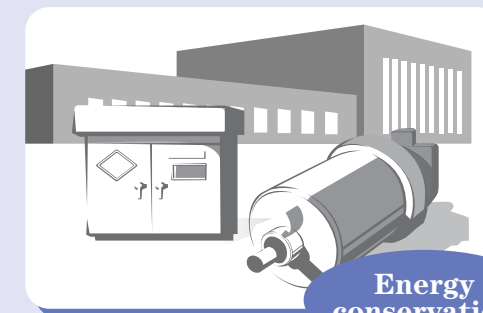

Energy conservation

### •Maintenance and periodic check data

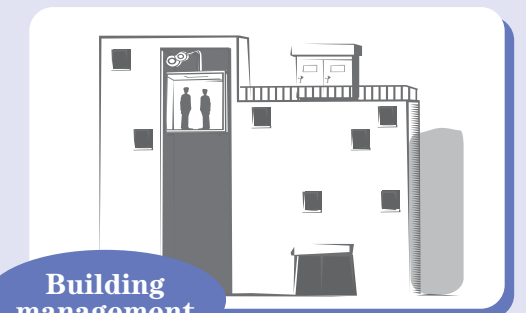

Building management

### •Demand data (CW140 only)

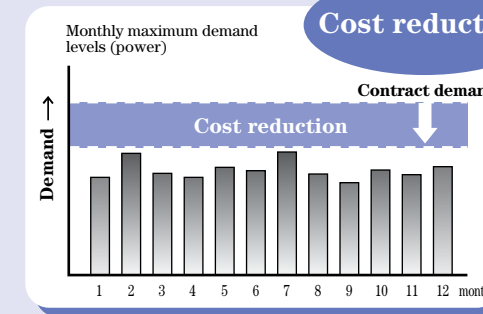

Cost reduction

### •Harmonics data (CW140 only)

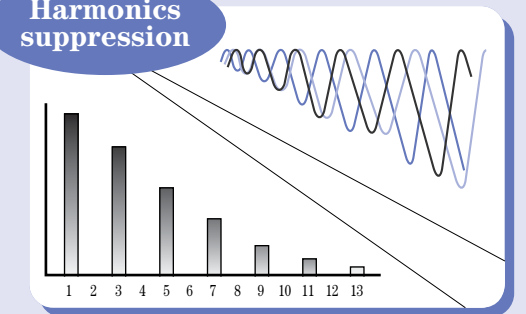

Harmonics suppression



# Low-cost tools to support your energy conservation efforts

As energy conservation becomes increasingly important, we are pleased to present low-cost clamp-on power meters designed to meet user needs for simple tools capable of measuring power values and instantaneous values.

## Useful features for energy conservation and power measurement

- Periodically save data as often as once a second**  
 Data can be saved at 1-second interval at fastest. This capability allows the CW120 Series to respond quickly to load fluctuations and measure transient responses in equipment.
- Check equipment operating conditions**  
 The CW120 Series has an instantaneous value filing function (enabling multiple data records to be saved in a single file when multiple measurements are taken) which is useful for determining equipment operating conditions.
- Wiring error check function**  
 This function helps ensure that measurement operations do not fail.
- Simultaneous measurement of multiple facilities**  
 Multiple CW120 Series units can start and stop integration simultaneously through externally controlled I/O.
- Works even with small electric energy values**  
 Easily change the decimal position (the number of digits following the decimal point) and display unit (Wh, kWh, MWh, GWh) on the electric energy display.

## Model CW121-□-1

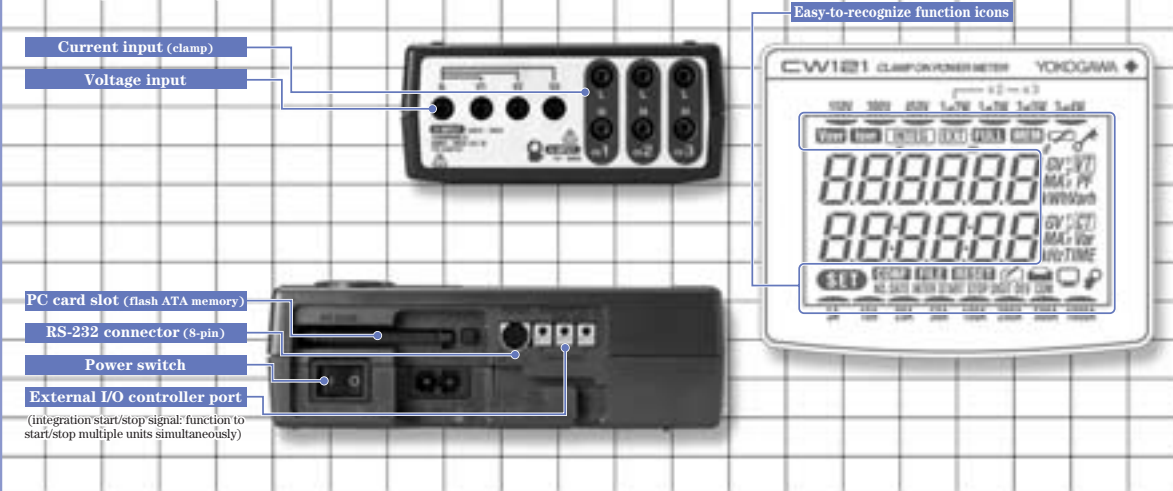

## Load measurements on multiple systems

- In addition to support for a variety of connection types, The CW120 Series can simultaneously measure the loads\* (facilities, equipment) on multiple systems sharing a common power supply.  
 CW120 (three-phase 3-wire model): 1φ2W × 2  
 CW121 (three-phase 4-wire model): 1φ2W × 2, × 3

1φ2W Three current systems (example)

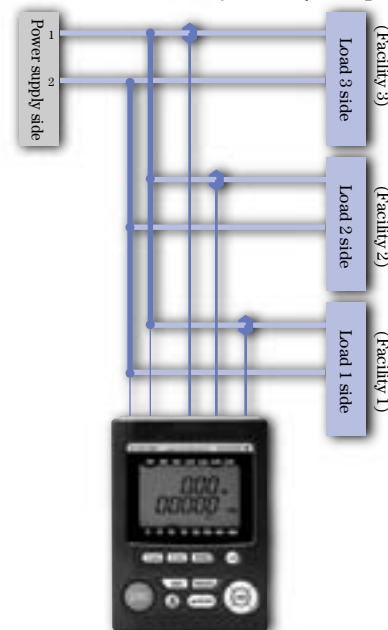

## Compact design

- The CW120 Series is compact in size (117×161×51mm (W×H×D)), making it ideal for installation in cubicles and inside distribution panels. Installation is even easier with the magnetic case (93023).
- Although the CW120 Series is small, it has a large backlit LCD.
- A new addition to the clamp lineup is a small-diameter current clamp (model 96033, capable of measurements in the range of 5–50 A) for measurements in tight spots and locations where many wires are jumbled together.

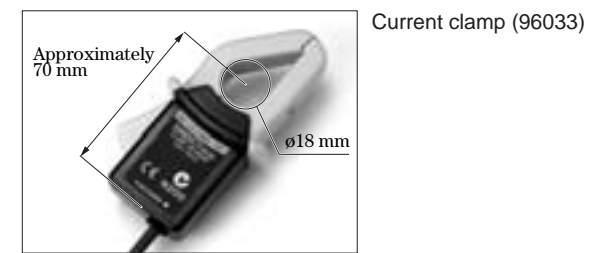

## Measurements

- The CW120 Series can be used for voltage measurements up to 495 V.
- A variety of connection types are supported, from single-phase 2-wire to three-phase 4-wire (CW120: three-phase 3-wire model; CW121: three-phase 4-wire model).
- Continuous measurement integration (accurate measurements can be obtained even if there are large load fluctuations)
- Plus/minus signs are shown for reactive power and power factor.
- The data saving interval can be set in the range of one second to one hour.

## Parameters setting tool (name: Toolbox)

The setting software allows you to set CW120 Series measurement conditions through a PC and save measurement data on a PC when the unit is connected to the PC through RS-232 or RS-485 port.

- Measurement conditions setting function**  
 This function makes it easy to set basic functions needed for measurement, such as start/stop time and date, wiring method, clamp type, voltage, and current range etc.
- File transfer function**  
 The data file stored in CF pack can be transferred to PC. Microsoft Excel can read transferred data file.  
 \* Toolbox is included as a standard feature (on two floppy disks).

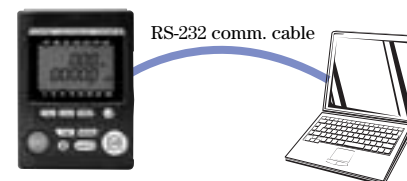

Microsoft, Windows, and Excel are trademarks or registered trademarks of Microsoft Corporation, the United States.



Setting screen



File transfer screen

## Data management and communication

- ① You can connect CW120 to a PC through dedicated RS-232 cable.
- ② A printer (sold separately) can be connected through RS-232 cable to print measurement data.
- ③ If you have a media reader connected to your PC, measurement data and settings can be uploaded directly to a PC from CF pack.

Wiring Method	Memory	Interval Time	Stored Period
3ø4W	16MB	1 Second	Approx 24 Hours
3ø4W	16MB	1 Minute	Approx 2 Months
3ø4W	16MB	10 Minutes	More than 1 Year
3ø4W	32MB	1 Second	Approx 40 Hours
3ø4W	32MB	10 Minutes	Approx 4 Months

\* Compact Flash cards with memory capacity up to 128 MB may be used (recommended brand: SanDisk).

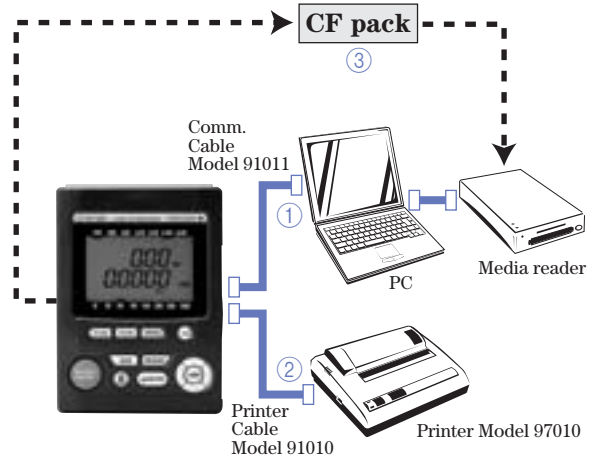

## Network Communication

CW120 In addition to proprietary communication protocol, MODBUS, PC-link and Power Monitor protocols are supported.

PC-link is a protocol for Yokogawa's Temperature controllers and PLCs.

Power Monitor protocol is a protocol for Yokogawa's Power Monitors. (PR201)

### Data Management by DAQLOGGER\*

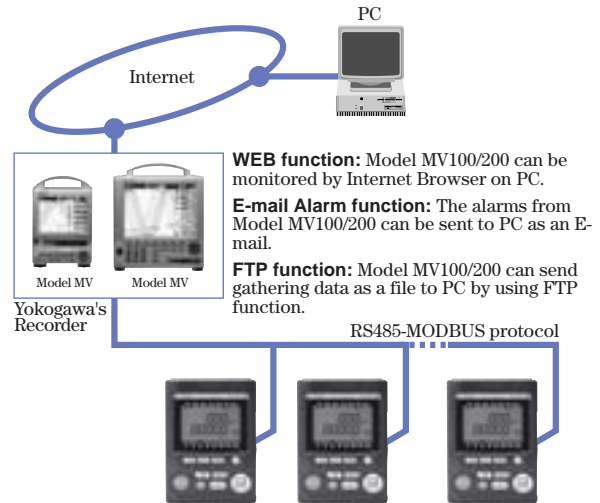

\* DAQLOGGER is Yokogawa's communication software for Windows 95/98/NT4.0/2000

## Remote monitoring

The RS-485 allows multiple use to be connected for remote monitoring.

\* RS-485/RS-232 converter is required to connect the CW120/CW121-□-2 (RS-485 communication spec) to the RS-232 port on your PC. Recommended brand and model: Yokogawa's RS-232/RS-485 Converter Model ML1.

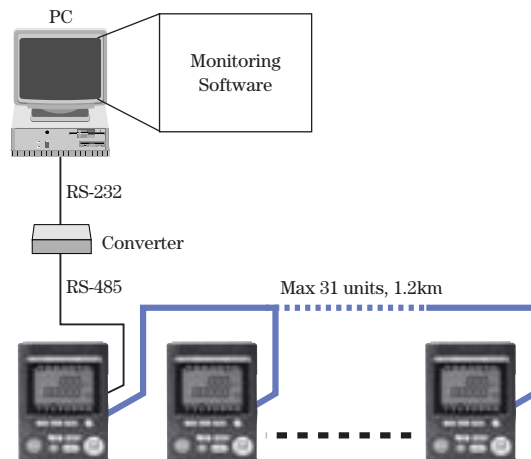

# Easy-to-view LCD screen

## Multi-language display

CW140 has an LCD screen (5.9 inches, 320×240 pixels). The data and parameters are easy to view.

Function key action and messages relating to procedures are displayed on the screen, making CW140 easier to use.



### Wh Measurements using the watt-hour key

**Useful functions**

**Increased speed**

Frequently used actions in electric energy mode are simplified.

Set conditions can be saved to internal memory. (In addition to the conditions which were valid at the end of the previous session, setting conditions 1 through 4 can be saved.) With this capability, even if the power is turned off and measurements are interrupted, the same condition settings will be used the next time the power is turned on. This makes it possible to continue the measurement process without difficulty.

### Enlarged display screen

**Easy-to-view screen**

In instant measure, you can enlarge the display of three desired parameters.

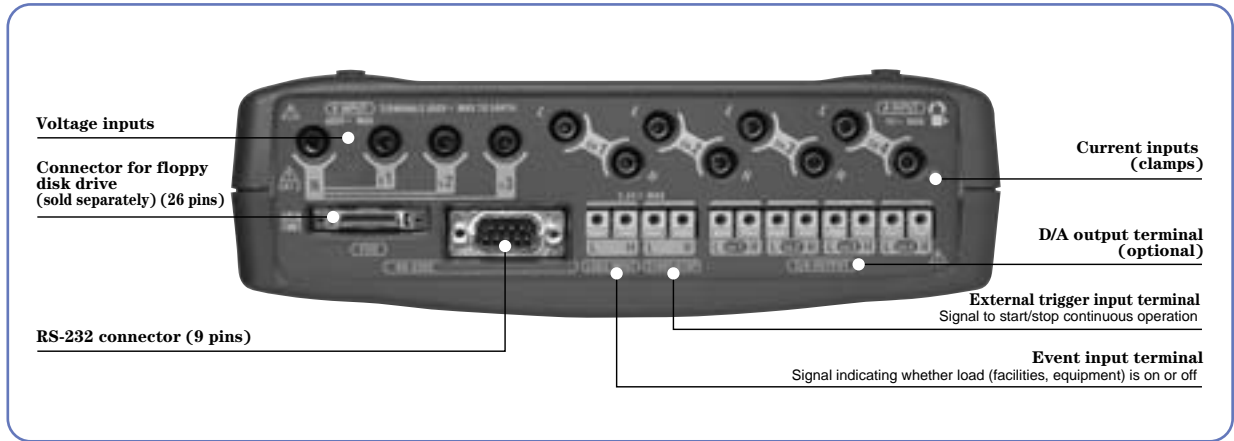

CW140

# Load measurements on two systems

A single CW140 power meter can measure the loads on 2 power systems sharing a common supply voltage.

CW140 has connectors for 4 current sensing clamps.

## Support for a variety of connection types

- In addition to support for a variety of connection types (from 1 $\phi$ 2W to 3 $\phi$ 4W), the CW140 can simultaneously measure the loads\* (facilities, equipment) on two systems sharing a common supply voltage.
- Supported connection types  
1 $\phi$ 2W, 1 $\phi$ 3W, 3 $\phi$ 3W2i, 3 $\phi$ 3W3i, 3 $\phi$ 4W
- 2-system load measurements  
1 $\phi$ 2W $\times$ 2, 1 $\phi$ 3W $\times$ 2, 3 $\phi$ 3W $\times$ 2  
(2-system load measurements are not supported in harmonics mode.)
- Because the CW140 supports 2-system load, as many as 4 current sensing clamps can be connected.)

3 $\phi$ 3W Two current systems (example)

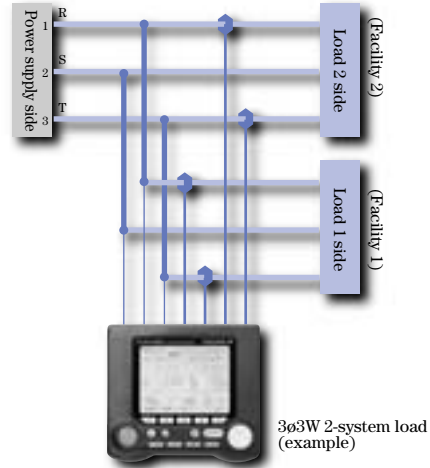

# Advanced data management

Data collected by CW140 can be used as part of an energy conservation program.

## Data management

- Measurement data can be stored in the internal memory.
- When a floppy disk drive (sold separately) is connected, measurement data can be saved to a 3.5-inch floppy disk.
- CW140 also has a function for copying internal memory data (files) to a floppy disk.
- Data can also be saved simultaneously to both internal memory and a floppy disk.

### ● Saving data (example)

#### For electric energy mode (3 $\phi$ 3W)

Saved data : 4 parameters  
Output interval : 30 minutes  
Internal memory : approx. 187 days  
Floppy disk (1.44MB) : approx. 292 days

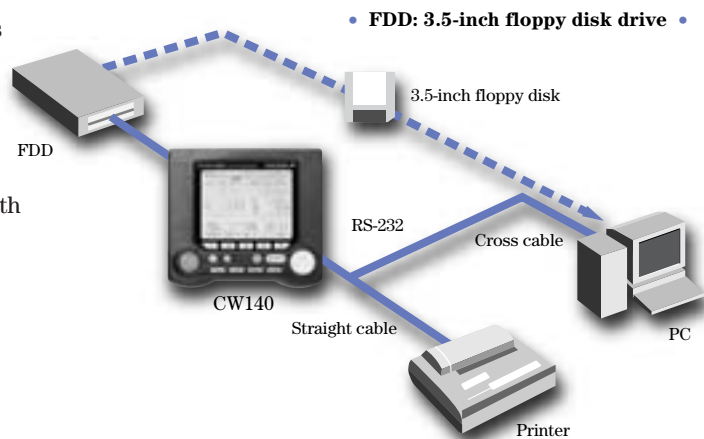

## Data communication (RS-232)

- You can connect CW140 to a PC through the RS-232 in order to transfer measurement data.
- You can also connect a printer through the RS-232 interface in order to print hard copies of measurement data.

### ● Analog output function (optional)

- CW140 has four analog outputs (-1 to +1vdc).

# A variety of application-specific functions

Useful functions for specific applications and measurement sites

## Wiring error check function

This function is used to check for wiring errors and select connections using the **WIRING** key.

◆ Five checks

- VOLTAGE INPUT
- CURRENT INPUT
- VOLT. PHASE SEQUENCE
- CLAMP DIRECTION ERR.
- FREQUENCY SOURCE

◆ Error message and connection diagram display

A function is provided to display an error message or a connection diagram if an error occurs in any of the above five checks.

Wiring error check function  
Connection diagram display screen  
(for 1φ3W×2)

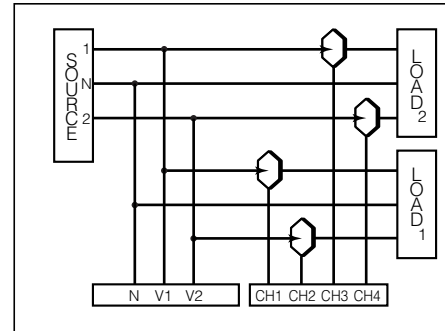

## Three Power supply types

CW140 can be powered through an AC adapter, as well as two types of batteries.

- ◆ AC adapter ( Standard accessory )
- ◆ AA alkaline dry cells (6) ( Standard accessory )
- ◆ Rechargeable nickel metal-hydride (NiMH) battery ( Optional accessory )

## Continuous measurement

CW140 supports continuous measurement, which is useful for data management, in all measurement modes. In addition, the user can select the method for starting and stopping continuous measurement.

- ◆ Instant mode : LOGGING
- ◆ Electric energy mode : INTEGRATE
- ◆ Demand mode : DEMAND
- ◆ Harmonics mode : LOGGING

### User-selectable continuous measurement start/stop method

#### START

- TIME
- TRIGGER
- MANUAL

#### STOP

- TIME
- TIMER
- TRIGGER
- MANUAL

## Event input

CW140 has a function for receiving a 0-5V signal indicating whether the load (facilities, equipment) is on or off. This is used when measuring (saving) continuous data, such as the power level. This makes it possible to manage load operations in association with the power level and other data.

## Useful display functions

Clock, displayed language switch, displayed value hold, NiMH battery charging, LCD contrast, LCD backlight, beep (key action confirmation), key lock, power saving mode, system reset, low-battery indication.

- ◆ Languages : English
- : French
- : Germany
- : Italian
- : Spanish
- : Japanese



# Obtaining smoother loads

Criteria for reviewing contracted power levels

CW140

## Electric energy mode

The integrated power level for a set time period (from the start to the end of the integration period) is displayed.

### Wh Simplified actions with the watt-hour key

Frequently used actions, such as setting conditions, are simplified. Used to save the settings which were current the last condition and to save setting conditions 1 through 4.

\* Display of Electric energy can be select the position of decimal point and unit of measurement (Wh, KWh, MWh, GWh)



Electric energy mode  
Integrated value screen  Switch  
Instantaneous value screen

## Demand mode

The demand time limit is the length of time specified for determining the average power.  
Demand power is the average power during the demand time limit period.

### The CW140 lets you set the demand time limit

- Demand time limit settings 5, 10, 15, or 30 minutes  
1, 2, 3, 4, 6, 8, 10, or 12 hours

### • Reference power setting

The reference power can be set in the range of 1W to 999.999TW.

**DEM. OVER** is displayed if the demand power (demand) exceeds the reference power.

### • Maximum demand power (maximum demand) and the time that maximum demand occurs are displayed



Demand screen  
Demand screen  Switch  
Instantaneous value screen

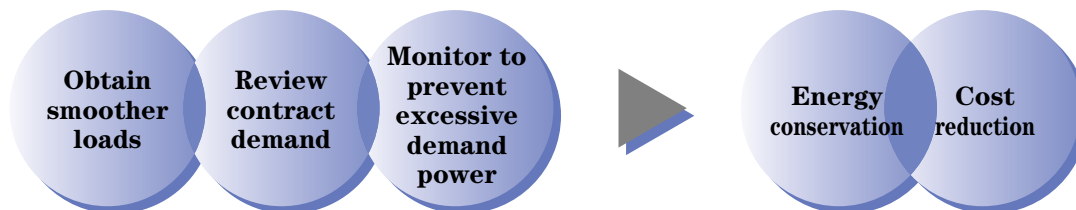

\* Display of Electric energy can be select the position of decimal point and unit of measurement (Wh, KWh, MWh, GWh)

## Instant mode

In this mode, CW140 displays voltage and current RMS values as well as active power, reactive power, apparent power, power factor, phase angle, frequency, and (with 3-phase) unbalanced rate. Reactive power can be calculated either with or without the reactive power meter method.

Function keys can be used to switch to the instantaneous value display screen even when measurements are being performed using electric energy mode or demand mode (does not apply to unbalanced rate).





# Harmonics mode

1st through 13th-order graph displays

CW140

Harmonics mode is a standard feature with CW140.

- ◆ Phases and wiring : 1 $\phi$ 2W, 1 $\phi$ 3W, 3 $\phi$ 3W, 3 $\phi$ 3W3i, 3 $\phi$ 4W
- ◆ Measurement frequency : 45-65 Hz (fundamental wave frequency)
- ◆ Analysis orders : 1st through 13th

CW140 can perform analysis of 1st through 13th orders serving as a basis for harmonics analysis. Such analyses can be used as basic data in controlling harmonics that occur when electrical facilities are used.

## Harmonics mode

### Table displays

#### Voltage/current

RMS, content, phase angle

All-RMS

Total harmonic distortion

IEEE: Distortion relative to fundamental wave

CSA: Distortion relative to All-RMS

Fundamental wave frequency

#### Power

Power level, power content, power phase angle

All-Power

All-Power Factor

Fundamental wave frequency

### Graph displays

#### Voltage/current

Any of the following can be displayed in a graph as an analysis parameter:  
RMS, content, phase angle.

#### Power

Any of the following can be displayed in a graph as an analysis parameter:  
power factor, power factor content, power factor phase angle

1<sup>st</sup>-order through 13<sup>th</sup>-order analysis parameter values can be displayed in a bar graph so that they are easy to understand. In addition, bar graph values can be displayed as numerical values.

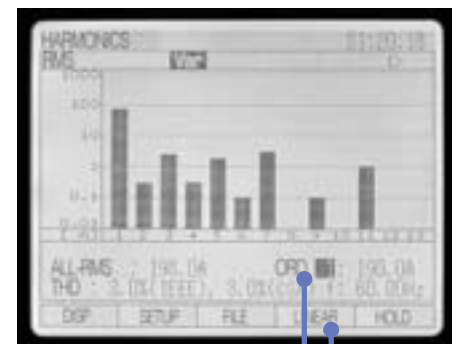

## Specifications

### Harmonics mode

System	PLL synchronization
Measurement frequency range	Fundamental wave frequency $45 \leq f \leq 65$ Hz
Number of analysis orders	1st-13th
FFT data length	512
FFT processing word length	32 bits
Window function	Rectangular
Sampling rate	$f \times 256$ Hz
Window width	Window width 2 periods off
Display fields	
Voltage and current	RMS, content, phase angle, All-RMS, total harmonic distortion (IEEE/CSA), fundamental wave frequency
Power	Power, power content, power phase angle, All-Power, All-Power Factor, fundamental wave frequency

Graph display	
Voltage and current	All-RMS, content, phase angle
Power	power, power content, power phase angle
Display accuracy	RMS, power $\pm(1.5\% \text{ rdg} + 1.5\% \text{ rng}) <1>$
Content	Value calculated from $<1> \pm 2 \text{ dgt}$
Phase angle	$\pm 5 \text{ deg}$
Total harmonic distortion	Value calculated from $<1> \pm 2 \text{ dgt}$
Logging function	The logging function can be used to take continuous measurements.
START setting	MANUAL, TIME, TRIGGER
STOP setting	MANUAL, TIMER, TIME, TRIGGER
Output interval	Setting in range of 2 minutes to 1000 hours (in 1-minute increments).

The harmonic analysis function does not work with two current systems. See page 9 for the harmonics equation.

# Data Analysis Program for CW Series (CW140/CW120/CW121)

Efficient Power and Energy Conservation Management through a PC

The AP140E is a data analysis program for CW Series. It efficiently manages the large amounts of measurement data needed as part of power management and energy conservation efforts, and provides multifaceted analysis through user-friendly operations.

AP140E



## Online Measurement

Measurement conditions can be set online and measurement data can be acquired in real time. Measurements can be started either manually or at a set time, and can be performed continuously at measurement intervals set by the user.

- **Real-time measurement at one-second intervals**

The measurement interval can be set to any time from one second to one day.

- **Continuous measurement for five days at one-minute intervals**

Measurements can be taken continuously over approximately two hours at one-second intervals, and over approximately five days at one-minute intervals.

- **Upper and lower limit alarm settings**

Upper and lower limit alarms can be set for five measurement parameters.

- **Easy-to-read enlarged display**

Alarm statuses and measurement values for any three selected measurement parameters can be enlarged on the display in real time during the measurement process.

- **Display of maximum and minimum values**

Maximum and minimum values since the start of measurement are displayed at the same time as the most recent measurements.

Online measurement screen

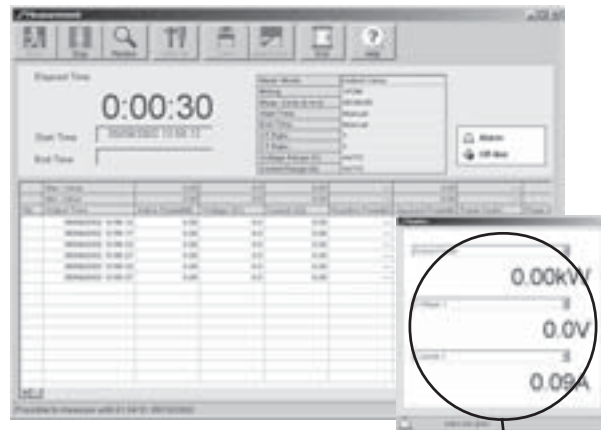

In manual mode, measurement is started immediately when the measurement start button is clicked. In timer mode, measurement does not start until the specified measurement start time.

Enlarge display window



## Displaying analysis graphs

- **Useful zoom-in time setting**

The data range to be viewed on the graph and its measurement interval can be changed, so you can identify those changes. (If you change the zoom-in time, click the redraw button.) In addition, the set zoom-in time can be moved forward and backward to change the graph display.

- **Easy-to-read data display**

Measurement data values can be checked as numerical values in the data display window. This feature can be turned on or off as needed.

- **User-defined Y-axis settings**

The Y-axis upper limit, lower limit, and the number of digits following the decimal point can be easily changed.

- **Reference value settings**

Reference values can be set. These are useful for comparing measurements against data such as power reduction targets.

Analysis graph screen



### Various graph types



You can easily select from a variety of graph types (broken-line, stepped, bar, component bar chart, etc.) according to your needs. In addition, details such as line types can be set.



## Displaying Forms

Measurement data displayed in a graph can be converted into a form through a single mouse click. The range displayed on the graph is fully and automatically converted into form data. This is an efficient way of compiling desired ranges of data in forms.

- **Changing displayed parameters**

Simply check the parameters you want displayed to change the displayed parameters.

- **Easy-to-make interval reports**

Interval reports, such as daily, weekly, and monthly reports, are easy to create through a single mouse click.

Form screen



# AP140E Specifications

## Online Measurement

### Settings

- The measurement mode (instantaneous value measurement, power measurement) can be selected.
- The wiring method (1 $\phi$ 2W, 1 $\phi$ 3W, 3 $\phi$ 3W, 3 $\phi$ 4W) can be selected.
- The measurement interval can be set in the range of one second to one day.
- Measurement can be started and stopped either manually or automatically based on a timer.
- VT ratio, CT ratio, clamp setting, voltage range, and current range can be set (see CW120 Series specifications for details).
- The data display unit and the number of digits following the decimal point for online measurement can be set.
- Upper limit and lower limit alarm values can be set for up to five measurement parameters.

### Continuous Measurement

- Measurement status information (wiring method, measurement interval, measurement start time, measurement stop time, voltage range, current range, VT ratio, CT ratio, measurement start time, measurement stop time, elapsed time) is displayed.
- During measurement, maximum value, minimum value, and alarm status (off-line, upper/lower alarms present/absent) for each measurement parameter are displayed.
- During measurement, information on as many as three measurement parameters can be enlarged on the display.
- Up to 8000 measurements can be taken in a single continuous measurement session.

Relationship between measurement interval and maximum measurement period (examples)

Measurement interval	Maximum measurement period
1 second	Approximately 2 hours
1 minute	Approximately 5 days
10 minutes	Approximately 55 days

Note: Continuous measurement exceeding 49 days is not possible in Windows 95 and 98 due to the limitations of these operating systems.

### Saving Data

- Data names and comments can be added to measurement data and registered in a database. Information can be saved as files in CW120 Series format.

## Data Management

- Display fields (registration number, data name, comments, data measurement period) can be sorted in ascending or descending order.
- Files saved in CW Series format and data saved on a PC card can be read and registered in a database with data names and comments added.
- Selected data can be saved as files in CW Series format.

Note: The maximum database size is approximately 500 MB.

## Graph Display

- Graphs can be customized (graph type, color, line width, etc.).
- In time series graphs, the zoom-in time (data start time, stop time, and measurement interval) can be set. In addition, separate parameters can be displayed as Y-axes on the left and right sides of the graph.
- The Y-axis range and reference value can be set.

### Printing

- Displayed graphs can be printed in color or black and white.

### Copying to Clipboard

- Displayed graph images can be copied to the clipboard (for pasting to applications such as Word and Excel).

## Displaying Forms

- The range of information displayed in a graph can be converted to and displayed as a form.
- The measurement parameters to be included in a form can be selected.
- The data display unit and the number of digits following the decimal point can be set.

### Printing

- Forms can be printed.

### Copying to Clipboard

- Measurement data for the displayed period can be copied to the clipboard or saved as a CSV file (for use in applications such as Excel).

## Package Contents

Contents	AP140E installation CD	1 pc.
----------	------------------------	-------

## System Requirements

Operating system	Windows 95/98, Windows NT4.0, Windows 2000, Windows Me, XP Note: Service packs may be needed in some cases
PC type	PC/AT compatible (DOS/V PC)
Display resolution	SVGA (800 × 600) or higher; XGA recommended
CPU	Intel Pentium II 233 MHz or faster recommended
RAM	64 MB or more
Hard drive	At least 600 MB free space required
Other	A 640 MB magneto-optical (MO) disk is recommended for backing up data.

Note: The program may not work properly if power save mode or screensavers are operating.

## Inputs

Parameter	Voltage (V)	Current (A)
Input type	Resistive potential division	Clamp detection
Rated value (range)	150/300/450 V	Clamp 96033: 5/10/20/50 A Clamp 96030: 20/50/100/200 A Clamp 96031: 50/100/200/500 A Clamp 96032: 200/500/1000 A
Wiring	CW120	Single-phase 2-wire, single-phase 3-wire, three-phase 3-wire
	CW121	Single-phase 2-wire, single-phase 3-wire, three-phase 3-wire, three-phase 4-wire
Input resistance	CW120	Approximately 1.5 MΩ
	CW121	Approximately 1.3 MΩ
Maximum allowed input	495 Vrms	Clamp 96033: 130 Arms Clamp 96030: 250 Arms Clamp 96031: 625 Arms Clamp 96032: 1000 Arms
A/D converter	Voltage/current input simultaneous conversion, 12-bit resolution	

## Measurement Input functions

Parameter	Voltage	Current/active power
Method	Digital sampling	
Frequency range	45–65 Hz (reciprocal system), detected from V1	
Crest factor	150/300 V range	Rated input: 2
	450 V range	Rated input: 1.56
Rated input:	3	
Active input range	10–110% of each range	
Display range	Lower limit	All ranges 1.5 V
	Upper limit	130% of each range, except 110% for 450 V range
Temperature coefficient	±0.05% rmg/C	±0.07% rmg/C (including clamp)
Display updating interval	Approximately one second	

## Instantaneous Value Measurement

- Measurement parameters: Voltage rms (V), current rms (A), active power (W), frequency (Hz)
- Measurement accuracy (at power factor 1, including clamp)
  - Voltage: ±(0.3% rdg + 0.2% rng)
  - Current/active power: ±(0.8% rdg + 0.4% rng) when using clamps 96030, 96031, and 96033  
±(1.2% rdg + 0.8% rng) when using clamp 96032
  - Frequency: ±(0.1% rdg + 1% dgt)
- Computation parameters: Reactive power (Var), power factor
- Computation accuracy: (value calculated from measurement) ±1 dgt
- Power factor influence: ±1.0% rmg cosφ = ±0.5 (relative to power factor 1) when using clamp 96030  
±2.0% rmg cosφ = ±0.5 (relative to power factor 1) when using clamps 96031, 96032, and 96033
- Reactive factor influence: ±1.0% rmg sinφ = ±0.5 (relative to reactive factor 1) when using clamp 96030  
±2.0% rmg sinφ = ±0.5 (relative to reactive factor 1) when using clamps 96031, 96032, and 96033

## Equations

- Voltage rms
 
$$V_{rms} = \sqrt{\frac{1}{T} \int_0^T v(t)^2 dt} = \sqrt{\frac{1}{T} \sum_{i=0}^T v(t)^2}$$
- Current rms
 
$$I_{rms} = \sqrt{\frac{1}{T} \int_0^T i(t)^2 dt} = \sqrt{\frac{1}{T} \sum_{i=0}^T i(t)^2}$$
- Active power
 
$$P = \frac{1}{T} \int_0^T v(t) \times i(t) dt = \frac{1}{T} \sum_{i=0}^T v(t) \times i(t)$$

Single-phase 3-wire, three-phase 3-wire  $\Sigma P = P1 + P2$   
 Three-phase 4-wire  $\Sigma P = P1 + P2 + P3$

v(t), i(t): Input signals  
 T: One period for input signal
- Reactive power and power factor

	Reactive power (Note 2)	Apparent power	Power factor (Note 2)
Single-phase 2-wire	$Q_i = \sqrt{((VA_i)^2 - P_i^2)}$	$VA = V \times A$	$P / VA$
Single-phase 3-wire	$Q_i = \sqrt{((VA_i)^2 - P_i^2)}$ i=1,2 $\Sigma Q = Q1 + Q2$	$VA_i = V_i \times A_i$ i=1,2 $\Sigma VA = VA1 + VA2$	$\Sigma P / \Sigma VA$
Three-phase 3-wire (Note 3)	$Q_i = \sqrt{((VA_i)^2 - P_i^2)}$ i=1,2 $\Sigma Q = Q1 + Q2$	$VA_i = V_i \times A_i$ i=1,2 $\Sigma VA = \sqrt{3}/2 (VA1 + VA2)$	
Three-phase 4-wire	$Q_i = \sqrt{((VA_i)^2 - P_i^2)}$ i=1,2,3 $\Sigma Q = Q1 + Q2 + Q3$	$VA_i = V_i \times A_i$ i=1,2,3 $\Sigma VA = VA1 + VA2 + VA3$	
Computation range	Rated value depends on V and A ranges.	Rated value depends on V and A ranges.	-1 ~ +1
Display resolution	Same as for active power.	Internal computation only; data not displayed or saved.	±1.000

- Note 1: In the case of distorted waves, there may be differences from other measuring instruments that are based on different measurement principles.
- Note 2: The polarity each phase determined by the reactive power meter method is multiplied and the polarity is displayed.
- Note 3: In the case of three-phase 3-wire and unbalanced inputs, there may be differences from other measuring instruments that are based on different measurement principles, or wiring.

## Electric Energy Measurement

- Measured parameters:
  - Active electric energy, regenerative electric energy (regenerative electric energy is not displayed on the screen; it is merely saved)
- Measurement accuracy: Active power measurement accuracy ±1 dgt (with standard settings)
- Integration function settings
  - Start/stop settings: Manual, timer, external trigger (control)
  - Output intervals: 1/2/5/10/15/30 seconds; 1/2/5/10/15/30 minutes; 1 hour
- Displayed digits:
  - This is set automatically based on the rated power, and the minimum resolution can be set



# Specifications 2

## Saving items

- Saving items: Voltage, current, active power, reactive power, power factor, frequency, active electric energy, regenerative electric energy

## Display Functions

- Display screen: Backlit segmented LCD
- Maximum number of displayed digits: 6 digits
- Electric energy: 6 digits
- Other parameters: 4 digits
- Range makeup: (rated values)

Voltage	Wiring	Clamp 96033							
		5.000 A	10.00 A	20.00 A	50.00 A	100.0 A	200.0 A	500.0 A	1.000 kA
150.0V	1ø2W	750.0 W	1.500 kW	3.000 kW	7.500 kW	15.00 kW	30.00 kW	75.00 kW	150.0 kW
	1ø3W	1.500 kW	3.000 kW	6.000 kW	15.00 kW	30.00 kW	60.00 kW	150.0 kW	300.0 kW
	3ø3W	1.500 kW	3.000 kW	6.000 kW	15.00 kW	30.00 kW	60.00 kW	150.0 kW	300.0 kW
	3ø4W	2.250 kW	4.500 kW	9.000 kW	22.50 kW	45.00 kW	90.00 kW	225.0 kW	450.0 kW
300.0V	1ø2W	1.500 kW	3.000 kW	6.000 kW	15.00 kW	30.00 kW	60.00 kW	150.0 kW	300.0 kW
	1ø3W	3.000 kW	6.000 kW	12.00 kW	30.00 kW	60.00 kW	120.0 kW	300.0 kW	600.0 kW
	3ø3W	3.000 kW	6.000 kW	12.00 kW	30.00 kW	60.00 kW	120.0 kW	300.0 kW	600.0 kW
	3ø4W	4.500 kW	9.000 kW	18.00 kW	45.00 kW	90.00 kW	180.0 kW	450.0 kW	900.0 kW
450.0V	1ø2W	2.250 kW	4.500 kW	9.000 kW	22.50 kW	45.00 kW	90.00 kW	225.0 kW	450.0 kW
	1ø3W	4.500 kW	9.000 kW	18.00 kW	45.00 kW	90.00 kW	180.0 kW	450.0 kW	900.0 kW
	3ø3W	4.500 kW	9.000 kW	18.00 kW	45.00 kW	90.00 kW	180.0 kW	450.0 kW	900.0 kW
	3ø4W	6.750 kW	13.50 kW	27.00 kW	67.50 kW	135.0 kW	270.0 kW	675.0 kW	1.350 MW

## Communication Functions

- Electrical specifications: Conforms to EIA RS-232 or EIA RS-485.
- Protocols: CW120/121 proprietary protocol, Power Monitor protocol (Standard protocol used for YOKOGAWA M&C's Power Monitor) PC link communication (Standard protocol used for YOKOGAWA M&C's Temperature Controllers) MODBUS communication (ASCII or RTU)
- Synchronization system: Start stop synchronization
- Baud rates: 1200, 2400, 4800, 9600, 19200, 38400 bps

## PC card interface

- Slot: PC card slot TYPE II
- Compatible card: ATA flash memory card
- Function specifications: Saving measurement data, saving and reading settings data

## Faulty Wiring Checking Functions

- Check details: Presence/absence of power input; check for frequency measurement range; voltage phase sequence; presence/absence of power input; whether current clamp is reverse-connected

## Scaling Function

- The VT ratio and CT ratio can be set.
- Settings ranges VT ratio: 1-10,000  
CT ratio: 1-10,000 (in increments of 0.01)

## External Control I/O (for RS-232 only; not provided for RS-485)

- These input and output can be used as signals for starting and stopping integrating measurement.
- Control input: TTL level or contact
  - Control output: TTL level

## Other Functions

Clock (typical precision: ±100 ppm), key lock, system reset

## General Specifications

- Environmental requirements: Indoor usage at an altitude of 2000 meters or less.
- Usage temperature and humidity ranges: 0-50°C, 5-85% RH (no condensation)  
0-40°C, 5-85% RH (no condensation) for UL, C-UL
- Storage temperature and humidity ranges: -20-60°C, 90% RH (no condensation)
- Insulating resistance: 500 V DC, 50 MΩ or greater  
Between voltage input terminals and case  
Between voltage input terminals and current input terminals, communication terminals, and control I/O terminals  
Between power line and case  
Between power line and current input terminals, communication terminals, and control I/O terminals
- Insulating withstand voltage: 5550 V AC for one minute  
Between voltage input terminals and case  
3250 V AC for one minute  
Between voltage input terminals and current input terminals, communication terminals, and control I/O terminals  
2300 V AC for one minute  
Between power line and case  
Between power line and current input terminals, communication terminals, and control I/O terminals
- Power supply: 100-240 V AC ±10%, 50/60 Hz
- Consumed power: 8 VA maximum
- External magnetic field effects: Within accuracy levels at 400 A/m
- External dimensions: Approximately 117×161×51 mm (W×H×D)
- Weight: Approximately 0.6 kg
- Terminals: Voltage input CW120: 3 terminals Banana terminals (safety terminals)  
CW121: 4 terminals Banana terminals (safety terminals)  
Current terminals CW120: 2 pairs Banana terminals (safety terminals)  
(H/L) CW121: 3 pairs Banana terminals (safety terminals)  
External control I/O 3 terminals (H/L/H) Screwless terminals  
terminals RS-485 4 terminals (+/-/SG/TM) M3 screw terminals
- Connectors: RS-232: Mini DIN 8-pin  
AC power supply: 2-pin
- Accessories: Voltage input probes: 3 for CW120, 4 for CW121  
Power cord, user's manual, operation guide, Toolbox (setting software)
- Safety standards: Compliant with EN61010-1, EN61010-2-031, UL3111-1 First Edition, CAN C22.2 No. 1010.1-92  
-Voltage input line Overvoltage category III (Max. input voltage : 600 Vrms)  
-Power line Overvoltage category II (Max. input voltage : 264 Vrms)  
Pollution degree 2
- EMC (emission): Compliant with EN55011, Group1, ClassA; EN61326; EN61000-3-2; EN61000-3-3
- EMC (immunity): Compliant with EN61326

# Specifications 1

CW140

Input		
Input	Input Voltage (V)	Current (A)
Input type	Resistive potential division	Clamp sensing
Ratings (ranges)	150, 300, 600 (V)	Clamp A: 20/50/100/200 (A) Clamp B: 200/500/1000 A Clamp C: 50/100/200/500 A
Input resistance	Approximately 1.3 MΩ	Approximately 100 kΩ (CW140)
Maximum allowed continuous input	600 Vrms	Clamp A: 250 Arms Clamp B: 1000 Arms Clamp C: 625 Arms
A/D conversion	Simultaneous voltage/current input conversion, 12-bit resolution	
Range switching	Manual, automatic, and settings entered through PC	
Auto-range functions	Range up: RMS is 110% or more of range rating, or sampled value is approximately 300% or more of rating. Range down: RMS is 30% or less of range rating, or sampled value does not exceed approximately 300% of range rating after range moves down.	

## Measurement functions

Parameter	Voltage	Current, active power, reactive power
Method	Digital sampling	
Frequency range	45 Hz to 1 kHz (harmonics mode: 45-65 Hz)	
Crest factor	3 (for rated input)	
Effective input range	10% to 110% of rated voltage/current range	
Temperature coefficient	± 0.03% of mg/°C	± 0.05% of mg/°C (including clamp)
Display update period	Approximately 1 sec (approximately 3 sec in harmonics mode)	

## Instant mode

Display fields	
Measured parameters	Voltage RMS (V), current RMS (A), active power (W), reactive power 1 (Var), frequency (Hz)
Calculated parameters	Reactive power 2 (Var), apparent power (VA), power factor, phase angle (°), 3φ unbalanced rate (°) Reactive power 1: With reactive power meter method Reactive power 2: Without reactive power meter method
Measurement accuracy	For power factor 1 (including clamp)
Voltage	45 Hz ≤ f ≤ 66 Hz: ± (0.1% rdg + 0.2% mg) 66 Hz < f ≤ kHz: ± (0.2% rdg + 0.4% mg)
Current, active power, reactive power 1	45 Hz ≤ f ≤ 66 Hz: ± (0.6% rdg + 0.4% mg) 66 Hz < f ≤ 1 kHz: ± (0.1% rdg + 0.8% mg) } Clamp A, C 45 Hz ≤ f ≤ 66 Hz: ± (0.1% rdg + 0.8% mg) : Clamp B
Calculation accuracy	(reactive power 2, power factor, apparent power, phase angle) 45 Hz to 1 kHz: (value calculated from measurement) ± 1 dgt
Power factor effects	For 45 Hz ≤ f ≤ 66 Hz
Active power	± 1.0% mg cos φ = ± 0.5 (relative to power factor 1) ± 0.2% mg cos φ = ± 0.5 (relative to power factor 1) (Clamp B and C)
Reactive power	± 1.0% mg sin f = ± 0.5 (relative to reactive power 1) ± 0.2% mg sin f = ± 0.5 (relative to power factor 1) (Clamp B and C)
Logging function	The logging function can be used to take continuous measurements.
Start setting:	Manual, specified time, external trigger (controlled)
End setting:	Manual, timer, specified time, external trigger (controlled)
Output interval:	Setting in range of 2 minutes to 1000 hours (in one-minute increments)

## Equations

Voltage RMS

$$V_{RMS} = \sqrt{\frac{1}{T} \int_0^T v(t)^2 dt} = \sqrt{\frac{1}{T} \sum_{i=0}^T v(i)^2}$$

Current RMS

$$I_{RMS} = \sqrt{\frac{1}{T} \int_0^T i(t)^2 dt} = \sqrt{\frac{1}{T} \sum_{i=0}^T i(i)^2}$$

Active power

$$P = \frac{1}{T} \int_0^T v(t) \times i(t) dt = \frac{1}{T} \sum_{i=0}^T v(i) \times i(i)$$

Reactive power (with reactive power meter method)

$$Q = \frac{1}{T} \int_0^T v(t) \times i \left( t + \frac{T}{4} \right) dt = \frac{1}{T} \sum_{i=0}^T v(i) \times i \left( i + \frac{T}{4} \right)$$

v(t), i(t): Input signals  
T: One period of input signal

	Active power	Reactive power
1φ 2W	P	Q
1φ 3W	ΣP=P <sub>1</sub> +P <sub>2</sub>	ΣQ=Q <sub>1</sub> +Q <sub>2</sub>
3φ 3W/3φ 3W 3i	ΣP=P <sub>1</sub> +P <sub>2</sub> +P <sub>3</sub>	ΣQ=Q <sub>1</sub> +Q <sub>2</sub> +Q <sub>3</sub>
3φ 4W	ΣP=P <sub>1</sub> +P <sub>2</sub> +P <sub>3</sub>	ΣQ=Q <sub>1</sub> +Q <sub>2</sub> +Q <sub>3</sub>

3φ voltage unbalanced rate

$$\text{Unbalanced rate} = \frac{V_b}{V_a} \times 100\%$$

Frequency: 45-440 Hz

Calculation accuracy:  
(calculation from measurement) ± 1%

• For 3φ3W

$$V_a = \sqrt{\frac{1}{6} (V_{12}^2 + V_{23}^2 + V_{31}^2) + \frac{2}{\sqrt{3}} \sqrt{V_s (V_s - V_{12})(V_s - V_{23})(V_s - V_{31})}}$$

$$V_b = \sqrt{\frac{1}{6} (V_{12}^2 + V_{23}^2 + V_{31}^2) - \frac{2}{\sqrt{3}} \sqrt{V_s (V_s - V_{12})(V_s - V_{23})(V_s - V_{31})}}$$

$$V_s = \frac{1}{2} (V_{12} + V_{23} + V_{31}) \quad V_{12}, V_{23}, V_{31}$$

• For 3φ4W

In the equations, substitute V<sub>1n</sub>, V<sub>2n</sub>, V<sub>3n</sub> or the 3φ3W voltages between wires.

	Reactive power (without reactive power meter method)	Apparent power	Power factor (Note 2)	Phase angle (Note 2)
1φ2W	Q=√(VA) <sup>2</sup> -P <sup>2</sup>	VA = V × A	With reactive power meter P/√(P <sup>2</sup> +Q <sup>2</sup> ) Without reactive power meter P / VA	With reactive power meter cos <sup>-1</sup> (P/√(P <sup>2</sup> +Q <sup>2</sup> )) Without reactive power meter cos <sup>-1</sup> (P / VA)
1φ3W	Q <sub>i</sub> = √(VA <sub>i</sub> ) <sup>2</sup> -P <sub>i</sub> <sup>2</sup> i=1,2 ΣQ=Q <sub>1</sub> +Q <sub>2</sub>	VA <sub>i</sub> =V <sub>i</sub> ×A <sub>i</sub> i=1,2 ΣVA=VA <sub>1</sub> +VA <sub>2</sub>	With reactive power meter	With reactive power meter
3φ3W (Note 3)	Q <sub>i</sub> = √(VA <sub>i</sub> ) <sup>2</sup> -P <sub>i</sub> <sup>2</sup> i=1,3 ΣQ=Q <sub>1</sub> +Q <sub>3</sub>	VA <sub>i</sub> =V <sub>i</sub> ×A <sub>i</sub> i=1,3 ΣVA= √3/2(VA <sub>1</sub> +VA <sub>3</sub> )	ΣP √(ΣP) <sup>2</sup> +Σ(Q) <sup>2</sup>	cos <sup>-1</sup> (ΣP/√(ΣP) <sup>2</sup> +Σ(Q) <sup>2</sup> )
3φ3W3i (Note 3)	Q <sub>i</sub> = √(VA <sub>i</sub> ) <sup>2</sup> -P <sub>i</sub> <sup>2</sup> i=1,3 ΣQ=Q <sub>1</sub> +Q <sub>3</sub>	VA <sub>i</sub> =V <sub>i</sub> ×A <sub>i</sub> i=1,3 ΣVA= √3/2(VA <sub>1</sub> +VA <sub>3</sub> )	Without reactive power meter ΣP/ΣVA	Without reactive power meter cos <sup>-1</sup> (ΣP/ΣVA)
3φ4W	Q <sub>i</sub> = √(VA <sub>i</sub> ) <sup>2</sup> -P <sub>i</sub> <sup>2</sup> i=1,2,3 ΣQ=Q <sub>1</sub> +Q <sub>2</sub> +Q <sub>3</sub>	VA <sub>i</sub> =V <sub>i</sub> ×A <sub>i</sub> i=1,2,3 ΣVA= VA <sub>1</sub> +VA <sub>2</sub> +VA <sub>3</sub>		
Calculation range	The ratings depend on the ranges for V and A.	The ratings depend on the ranges for V and A.	-1 ~ +1	-180 ~ +180
Display resolution	Same as for active power.	Same as for active power.	±1.000	±180.0

Note 1: For distortion wave input: There may be discrepancies between the CW140 and other instruments that operate based on other measurement principles.  
If either voltage or current input is 0.4% or less of range rating:  
0 (zero) is displayed for Reactive power 2<sup>nd</sup> and apparent power.  
— — — (dashes) are displayed for factor and phase angle.  
Reactive power 2<sup>nd</sup>: without reactive power meter method.

Note 2: The polarity each phase determined by the reactive power meter method is multiplied and the polarity is displayed.

Note 3: In the case of three-phase 3-wire and unbalanced inputs, there may be differences from other measuring instruments that are based on different measurement principles, or wiring.

## Frequency measurement

Measurement input	Voltage input: V1, V2, V3 Current input: CH1, CH2, CH3, CH4	Select one of the parameters on the left.
Measurement frequency range	45 Hz to 1 kHz (harmonics mode : 45 -65Hz)	
Accuracy	± (0.1% rdg + 1 dgt)	

Low-pass filter function

The low-pass filter function can be set in the system settings.  
Cutoff frequency: 300 Hz

## Electric energy mode

Display fields	Integrate screen	Active power (Wh), recursive power (Wh), lag reactive power (Varh), lead reactive power (Varh)
	Instant screen	Instantaneous value measurement function measurement/calculated value display screen (does not apply to unbalanced rate)
Display accuracy	Instantaneous value measurement function active power measurement accuracy ± 1 dgt	
Integration function settings	Start setting	Manual, specified time, external trigger (controlled)
	End setting	Manual, timer, specified time, external trigger
Output interval	Setting in range of 2 minutes to 1000 hours ( in 1-minute increments ).	
Quick actions using Wh key.		

# Specifications 2

Demand mode		
Display fields	Display during demand	Maximum demand and time of occurrence, previous power demand, power since start of demand, power during current time limit, power factor, load factor, remaining demand time
	Display after demand ends	Maximum demand and time of occurrence, average for each demand type, power from start to end of demand, average load factor
	Instantaneous screen	Instantaneous value measurement function measurement, calculated value display screen (does not apply to unbalanced rate)
Display accuracy	Instantaneous value measurement function active power measurement accuracy $\pm 1$ dgt	
Demand function settings	Demand time limit settings (output intervals)	5, 10, 15, or 30 minutes : 1, 2, 3, 4, 6, 8, 10, or 12 hours
Load factor calculation : (demand/reference power) $\times 100\%$		

Display functions	
Display screen	Semitransparent LCD (320 $\times$ 240 pixels)
Included functions	Backlight ON/OFF, contrast adjustment
Maximum digits	
Other than power	4 digits
Power (active, reactive, recursive)	6 digits
Japanese/English / French / Germany / Italian / Spanish language switching	

Voltage (V)	Phases and wiring	Current (A) range					
		Clamp A		Clamp C		Clamp B	
		20.0	50.0	100.0	200.0	500.0	1,000k
150.0	1 $\phi$ 2W	3.000kW	7.500kW	15.00kW	30.00kW	75.00kW	150.0kW
	1 $\phi$ 3W	6.000kW	15.00kW	30.00kW	60.00kW	150.0kW	300.0kW
	3 $\phi$ 3W	6.000kW	15.00kW	30.00kW	60.00kW	150.0kW	300.0kW
	3 $\phi$ 4W	9.000kW	22.50kW	45.00kW	90.00kW	225.0kW	450.0kW
300.0	1 $\phi$ 2W	6.000kW	15.00kW	30.00kW	60.00kW	150.0kW	300.0kW
	1 $\phi$ 3W	12.00kW	30.00kW	60.00kW	120.0kW	300.0kW	600.0kW
	3 $\phi$ 3W	12.00kW	30.00kW	60.00kW	120.0kW	300.0kW	600.0kW
	3 $\phi$ 4W	18.00kW	45.00kW	90.00kW	180.0kW	450.0kW	900.0kW
600.0	1 $\phi$ 2W	12.00kW	30.00kW	60.00kW	120.0kW	300.0kW	600.0kW
	1 $\phi$ 3W	24.00kW	60.00kW	120.0kW	240.0kW	600.0kW	1,200MW
	3 $\phi$ 3W	24.00kW	60.00kW	120.0kW	240.0kW	600.0kW	1,200MW
	3 $\phi$ 4W	36.00kW	90.00kW	180.0kW	360.0kW	900.0kW	1,800MW

Current range Clamp A: 20, 50, 100, 200 (A)  
Clamp B: 200, 500, 1000 (A)  
Clamp C: 50, 100, 200, 500 (A)

Averaging function	
The averaging function can be set through system settings. Moving average type Number of averages: Set between 2 and 10.	
Scaling function	
The VT ratio and CT ratio settings can be set through system settings. Setting range VT ratio: 1-10000 CT ratio: 0.01-10000	

Wiring error check function	
This function checks the wiring connection status based on five parameters, and displays the results.	

Save and print functions (file functions)	
Internal memory	1 MB
Floppy disks	1.2 MB or 1.44 MB (only when using an externally connected floppy disk drive)
Printer	Printing (only when using an externally connected printer)
Reading	Display values, set values
Saving	Display values, set parameters, set values
Printing	Display values, set parameters, set values

Communication functions (RS-232)	
Electrical specifications	As per EIA RS-232.
Synchronization system	Start-stop synchronization
Baud rate	1200, 2400, 4800, 9600, 19200 bps

Harmonics mode equations	
Equations	
Voltage RMS Current RMS	$V_n = \sqrt{\frac{(V_{nr})^2 + (V_{ni})^2}{2}}$ $A_n = \sqrt{\frac{(A_{nr})^2 + (A_{ni})^2}{2}}$
RMS nth order content	$\frac{\text{nth order RMS}}{\text{fundamental wave RMS}} \times 100\%$
RMS phase angle	$\theta_{n=} (\text{nth order harmonic voltage phase}) - (\text{fundamental wave phase}) \times n$ $= \tan^{-1}(\frac{V_{nr}}{V_{ni}}) - \{\tan^{-1}(\frac{V_{1r}}{V_{1i}})\} \times n$ $\theta_{n=} (\text{nth order harmonic voltage phase}) - (\text{fundamental wave phase}) \times n$ $= \tan^{-1}(\frac{A_{nr}}{A_{ni}}) - \{\tan^{-1}(\frac{A_{1r}}{A_{1i}})\} \times n$
Total Harmonic Distortion content (IEEE:)	$THD(IEEE) = \sqrt{\frac{\sum_{n=2}^{13} (\text{nth order harmonic voltage (current) RMS})^2}{(\text{fundamental wave voltage (current) RMS})^2}}$
Total Harmonic Distortion content (CSA)	$THD(CSA) = \sqrt{\frac{\sum_{n=2}^{13} (\text{nth order harmonic voltage (current) RMS})^2}{\sum_{n=1}^{13} (\text{nth order harmonic voltage (current) RMS})^2}}$
Power	1 $\phi$ 2W $P_n = V_{nr} \times A_{nr} + V_{ni} \times A_{ni}$ 1 $\phi$ 3W $P_n = P_{1n} + P_{2n}$ 3 $\phi$ 3W $P_n = P_{1n} + P_{3n}$ 3 $\phi$ 4W $P_n = P_{1n} + P_{2n} + P_{3n}$
Power nth order content	$\frac{\text{nth order active power}}{\text{fundamental wave active power}} \times 100\%$
Power phase angle	<ul style="list-style-type: none"> <li>With reactive power meter method <math>\theta_{Pn} = \tan^{-1}(\frac{Q_n}{P_n})</math> 1<math>\phi</math>2W <math>Q_n = V_{nr} \times A_{ni} - V_{ni} \times A_{nr}</math> 1<math>\phi</math>3W <math>Q_n = Q_{1n} + Q_{2n}</math> 3<math>\phi</math>3W <math>Q_n = Q_{1n} + Q_{3n}</math> 3<math>\phi</math>4W <math>Q_n = Q_{1n} + Q_{2n} + Q_{3n}</math></li> <li>Without reactive power meter method <math>\theta_{Pn} = \cos^{-1}(\frac{P_n}{\sqrt{VA}})</math> 1<math>\phi</math>2W <math>VA_n = V_n \times A_n</math> 1<math>\phi</math>3W <math>VA_n = V_{1n} \times A_{1n} + V_{2n} \times A_{2n}</math> 3<math>\phi</math>3W <math>VA_n = \frac{\sqrt{3}}{2} (V_{1n} \times A_{1n} + V_{3n} \times A_{3n})</math> 3<math>\phi</math>4W <math>VA_n = V_{1n} \times A_{1n} + V_{2n} \times A_{2n} + V_{3n} \times A_{3n}</math></li> </ul>
All-RMS	$\sum_{n=1}^{13} V_n, \sum_{n=1}^{13} A_n$
All-power	$\sum_{n=1}^{13} P_n$
All-power factor	<ul style="list-style-type: none"> <li>Without reactive power meter method <math>\sqrt{\frac{\sum_{n=1}^{13} P_n}{(\sum_{n=1}^{13} P_n)^2 + (\sum_{n=1}^{13} Q_n)^2}}</math></li> <li>Without reactive power meter method <math>\frac{\sum_{n=1}^{13} P_n}{\sum_{n=1}^{13} P_n (V_n \times A_n)}</math></li> </ul>

Data representing 512 obtained samples are put through FFT calculations to analyze the nth order harmonic components as follows.  
nth order harmonic voltage RMS  $V_n$  : ( $V_{nr}, V_{ni}$ )  
nth order harmonic current RMS  $A_n$  : ( $A_{nr}, A_{ni}$ )  
 $n$  : Number of orders  
 $V_{nr}, A_{nr}$  : Real-number components following FFT calculation  
 $V_{ni}, A_{ni}$  : Imaginary-number components following FFT calculation  
 $n$  : Number of orders  
 $V_{nr}, A_{nr}$  : Real-number components following FFT calculation  
 $V_{ni}, A_{ni}$  : Imaginary-number components following FFT calculation  
 $P_{1n} - P_{3n}$  : Active power ( element of nth order )  
 $Q_{1n} - Q_{3n}$  : Reactive power ( element of nth order )  
RMS phase angle: Phase angle of nth order harmonic components relative to fundamental wave component of input signal  
Power phase angle: nth order current phase relative to nth order voltage

# Specifications 3

CW140

## D/A output (optional)

Output voltage	$\pm 1$ V relative to rating for each range
Output current	$\pm 1$ mA (at load resistance of 1k $\Omega$ )
Number of outputs	4
Output data selection	Selected from measurement parameters for each mode.
Accuracy	$\pm$ (measurement accuracy + 0.5% FS)
Updating period	Same as display updating period

## Frequency

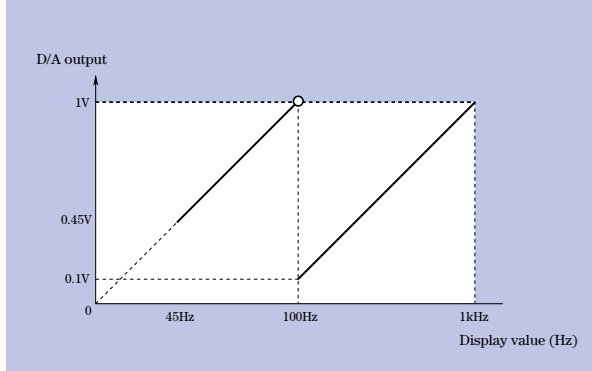

## Integrate

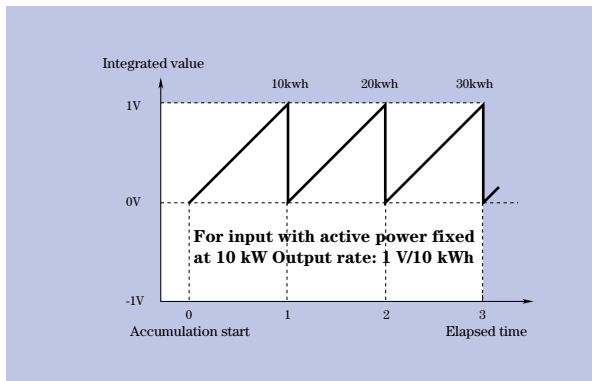

## Other items

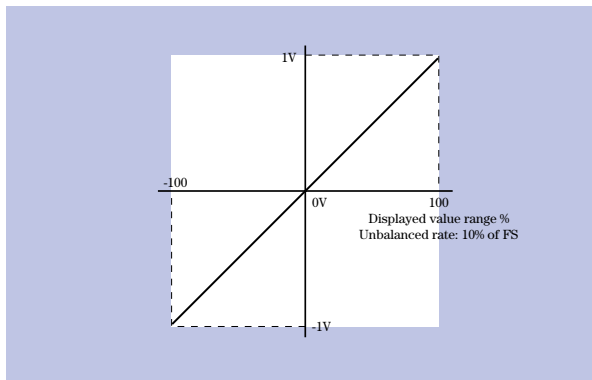

## Externally controlled input

Inputs can be externally controlled as logging, integration, and demand start/stop signals. 0V/5 V

## Event input

CW140 can read a signal indicating whether the load (measured equipment) is on or off. 0V/5 V

## Other included functions

Clock, displayed language switch (Japanese, English, French, German, Italian, Spanish), displayed value hold, NiMH battery charging, LCD contrast, LCD backlight, beeps (key action confirmation), key lock, power saving mode, system reset, low-battery indication

## General specifications

Ambient temperature and humidity ranges	5 to 40°C, 35 to 80%RH (no condensation) 0-40°C, 5-85% RH (no condensation) for UL, C-UL	
Storage temperature and humidity ranges	-20 to 60°C, 90% RH or less (no condensation)	
Insulating resistance	50 MW or more at 500 V DC across voltage input <ul style="list-style-type: none"> <li>• Between voltage input terminals and case</li> <li>• Between voltage input terminals and following &lt;1&gt; to &lt;5&gt; terminals  <ul style="list-style-type: none"> <li>&lt;1&gt; Current input terminal</li> <li>&lt;2&gt; Communication terminal</li> <li>&lt;3&gt; Floppy disk drive connector</li> <li>&lt;4&gt; D/A output terminal</li> <li>&lt;5&gt; Control input terminal</li> </ul> </li> <li>• Between voltage input terminals and AC adapter power line</li> <li>• Between case and AC adapter power line</li> </ul>	
Insulating withstand voltage	3700 V AC for 1 minute <ul style="list-style-type: none"> <li>• Between voltage input terminals and case</li> <li>• Between voltage input terminals and following &lt;1&gt; to &lt;5&gt; terminals</li> </ul> 2300 V AC for 1 minute <ul style="list-style-type: none"> <li>• Between voltage input terminals and AC adapter power line</li> <li>• Between case and AC adapter power line</li> </ul>	
Power supply	AC voltage (Standard accessory) AC adapter: 100-240 V (50/60 Hz)	
NiMH battery (Optional accessory)	NiMH battery pack (rechargeable while installed in CW140) Running time: approx. 7 hours (with LCD backlight off and with no floppy disk drive connected) Recharging time: approx. 1.5 hours	
AA alkaline dry cells (6) (Standard accessory)	Running time: approx. 3 hours (with LCD backlight off and with no floppy disk drive connected)	
Power consumption	approx. 3 VA (typical) (with LCD backlight off and with no floppy disk drive connected)	
External magnetic field effects	Within precision range at 400 A/m	
External dimensions	Approximately 206 (W) × 65 (H) × 184 (D) mm	
Weight	Approximately 1.2 kg (batteries not included)	
Terminals	Voltage input	4 terminals Banana terminals (safety terminals)
	Current input H/L	4 terminals Banana terminals (safety terminals)
	External control input	H/L 2 terminals X2 Screwless terminals
	Event input	H/L 2 terminals X2 Screwless terminals
	D/A output (optional)	H/L 2 terminals X2 Screwless terminals
Accessories :	Voltage input probes(4), AA alkaline dry cells(6), AC adapter(1)	
Safety standard	<ul style="list-style-type: none"> <li>• CW140-F, R, S EN61010-1, EN61010-2-031 (Over voltage Category II 600V, Category III 300V Pollution Degree 2, Indoor use)</li> <li>• CW140-D UL3111-1, First Edition CAN22.2 No.1010.1-92 (Over voltage Category III 600V, Pollution Degree 2, Indoor use)</li> </ul>	
Emission	EN55011-Group1, Class A EN61326-1, Class A EN61000-3-2, Class A EN61000-3-3	
Immunity	EN61326-1	

## External dimensions (CW140)

Unit = mm (inch)

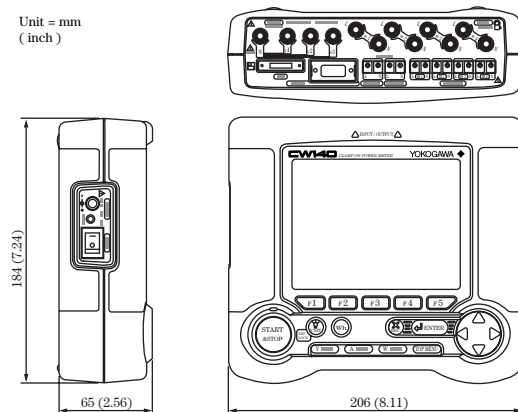



# CW120 Models and Suffix code

CW120

## Model name and suffix code

Model (Part No.)	Suffix code	Option code	Description
CW120			Three-phase 3-wire
CW121			Three-phase 4-wire
Power cord	-D		AC power cord (UL/CSA Standard)
	-F		AC power cord (VDE Standard)
	-R		AC power cord (SAA Standard)
	-S		AC power cord (BS Standard)
Communication	-1		RS-232 communication interface
	-2		RS-485 communication interface
Options for CW 120	/C1		Two 200 A current clamp-on probes (96030)
	/C3		Two 500 A current clamp-on probes (96031)
	/C5		Two 700 A current clamp-on probes (96032)
	/C7		Two 50 A current clamp-on probes (96033)
Options for CW 121	/C2		Three 200 A current clamp-on probes (96030)
	/C4		Three 500 A current clamp-on probes (96031)
	/C6		Three 700 A current clamp-on probes (96032)
	/C8		Three 50 A current clamp-on probes (96033)
Other options Communication (RS232)	/PM1		Main unit case, carrying case, CF pack, and 91011
Basic Package	/PB1		Main unit case, carrying case + CF pack

## Accessories supplied at no extra cost

Product Name	Part No.	Qty
1. Power cord		3
2. Voltage probes (for CW 120)	91018	3
	91007	4
3. User's Manual	IM CW120-E	1
4. Operation Guide	IM CW-120PE	1

## Optional Accessories

### Carrying case



93022

### Main unit case



93023

### Portable case



93024

CW120 main unit can be packed in the carrying case with accessories like the current clamps and voltage probes. It also holds the other accessories.

Includes magnet and stand

### Power cable



98030

### Printer



97010

This cable supplies power from a measurement circuit, length 1.5m  
\*Not applied to CE and UL

## Optional Accessories

	Parts No.	Description
Voltage probe	91007	Four per set
Voltage probe	91018	Three per set
Communication cable	91011	RS232 communication cable for PC (9-pin)
Printer cable	91010	RS232 printer cable, length 1.5 m
Printer	97010	Includes one roll of thermal paper and one battery pack
AC adapter for printer	94006	Power Supply 200-240 VAC
AC adapter for printer	94007	Power Supply 100-120 VAC
Printer thermal paper	97080	10 rolls
AC adapter for 96035	A1022UP	For AC 120V
	B9108WB	For AC 220-240V
Data Analyzing Program	AP140E	

# CW140 Model and Suffix Code

CW140

## Model name and suffix codes

Model	Suffix code	Specifications
CW140		
AC adapter	-D	Power cord : UL/CSA standard
	-F	: VDE standard
	-R	: SAA standard
	-S	: BS standard
	/DA	D/A output
	/C1	Clamp-on Probe for 20/200 A (2 pcs/set)
	/C2	Clamp-on Probe for 20/200 A (4 pcs/set)
	/C3	Clamp-on Probe for 500 A (2 pcs/set)
	/C4	Clamp-on Probe for 500 A (4 pcs/set)
	/C5	Clamp-on Probe for 700 A (2 pcs/set)
	/C6	Clamp-on Probe for 700 A (4 pcs/set)
	/C7	Clamp-on Probe for 50 A (2 pcs/set)
/C8	Clamp-on Probe for 50 A (4 pcs/set)	
/PM1	NiMH battery pack and carrying case	
/PM2	PM1 and FDD unit	

## Optional Accessories

### Carrying case



93020

### FDD unit



97020

CW140 main unit can be packed in the carrying case with accessories like current clamps and voltage probes, without disconnecting them from the main unit. It also holds the other accessories.

3.5-inch floppy disk drive

## Optional accessories

Name	Model No.	Description
Voltage probes (4 pcs/set)	91007	
NiMH battery pack	94004	
Printer	97010	
AC adapter (for printer, Europe)	94006	
AC adapter (for printer, USA)	94007	
Thermal paper for printer (10 rolls)	97080	
AC adapter for 96035	A1022UP	For AC 120V
	B9108WB	For AC 220-240V
Data Analyzing Program	AP140E	

# Common Accessories for CW120/121 and CW140

Item	96030 Clamp-on Current Probe	96031 Clamp-on Current Probe	96032 Clamp-on Current Probe	96033 Clamp-on Current Probe	
Measuring range	0-200 Arms AC (300 Apk)	0-500 Arms AC (750 Apk)	0-700 Arms AC (990 Apk)	0-50 Arms AC	
Output voltage	0-0.5 Vrms AC (2.5 mV/A)	0-0.5 Vrms AC (1 mV/A)	1000 Arms (1414 Apk) for 5 minutes	0-0.5 Vrms AC (10 mV/A)	
Accuracy	Amplitude	±1.5% rdg ±0.4 mV (20 Hz to 45 Hz) ±0.5% rdg ±0.1 mV (45 Hz to 66 Hz) ±0.8% rdg ±0.2 mV (66 Hz to 1 kHz) ±2.0% rdg ±0.4 mV (1 kHz to 20 kHz)	±1.5% rdg ±0.4 mV (20 Hz to 45 Hz) ±0.5% rdg ±0.1 mV (45 Hz to 66 Hz) ±0.8% rdg ±0.2 mV (66 Hz to 1 kHz)	0-0.25 Vrms AC (0.25 mV/A) ±1.0% rdg ±0.2 mV (45 Hz to 66 Hz)	±1.0% rdg ±0.3 mV (20 Hz to 45 Hz) ±0.5% rdg ±0.1 mV (45 Hz to 66 Hz) ±0.8% rdg ±0.2 mV (66 Hz to 1 kHz) ±1.0% rdg ±0.3 mV (1 kHz to 5 kHz) ±3% rdg ±0.4 mV (5 kHz to 20 kHz)
	Phase	±0.5° (45 Hz to 1 kHz)	±1.0° (45 Hz to 1 kHz)	±1.0° (50 A or more, 45 Hz to 66 Hz)	±1.0° (45 Hz to 1 kHz)
Output impedance	Approx. 6 Ω	Approx. 2.4 Ω	Approx. 100 Ω (max.)	Approx. 18 Ω	
External magnetic field effects	0.1 A equivalent or less (at 400 A/m, 50/60 Hz)	0.2 A equivalent or less (at 400 A/m, 50/60 Hz)	0.5 A equivalent or less (at 400 A/m, 50/60 Hz)	0.1 A equivalent or less (at 400 A/m, 50/60 Hz)	
Conductor position effects	±0.5% (at 20-200 A, 45 Hz to 1 kHz)	±0.5% (at 50-500 A, 45 Hz to 1 kHz)	±0.5% (at 200-1000 A, 45 Hz to 66 Hz)	±0.5% (at 1-50 A, 45 Hz to 1 kHz)	
Operating circuit voltage	600 Vrms AC max.			300 Vrms AC max.	
External dimensions	Approx. 73 (W) × 130 (H) × 30 (D) mm		Approx. 100 (W) × 172.5 (H) × 32 (D) mm	Approx. 52 (W) × 106 (H) × 25 (D) mm (excluding protrusions)	
Weight	Approx. 300 g		Approx. 500 g	Approx. 220 g	
Output cable length	Approx. 3 meters				

## External Dimensions

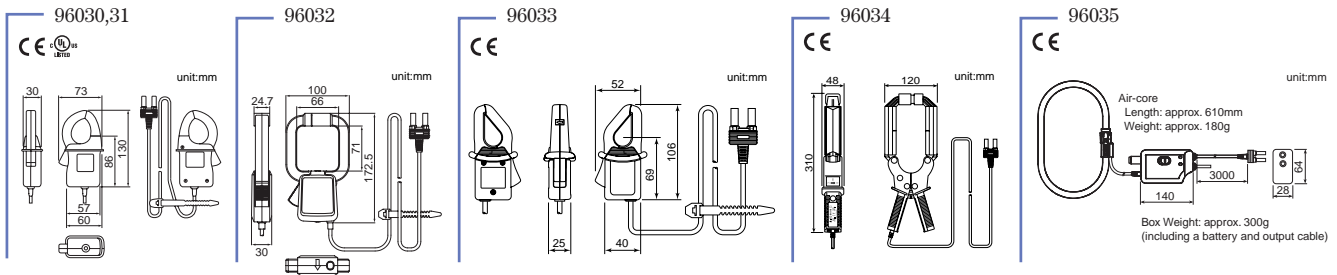

Item	96034 Clamp-on Current Probe			96035 Clamp-on Current Probe	
Range type	1000 A	2000 A	3000 A	3000 A	300 A
Measuring range	0-1000 Arms AC	0-2000 Arms AC	0-3000 Arms AC	0-3000 Arms AC	0-300 Arms AC
Output voltage	0-0.5 Vrms AC (0.5 mV/A)	0-0.5 Vrms AC (0.25 mV/A)	0-0.5 Vrms AC (0.1667 mV/A)	0-0.5 Vrms AC (0.1667 mV/A)	0-0.5 Vrms AC (1.667 mV/A)
Accuracy (for temperature of 23°C ±5°C, relative humidity of 20-70%, and sine wave input)	Amplitude	±1% rdg ±0.045 mV (1-20 A) ±1% rdg (20-1200 A)	±1% rdg ±0.0225 mV (1-20 A) ±1% rdg (20-2400 A)	±1% rdg ±0.015 mV (1-20 A) ±1% rdg (20-3600 A)	±1% rdg (5-3000 A, 45 Hz to 66 Hz) ±3% rdg (100 A, 10 Hz to 10 kHz)
	Phase	Not specified (1-20 A) ±1.0° (20-200 A) ±0.5° (200-1200 A)	Not specified (1-20 A) ±1.0° (20-200 A) ±0.5° (200-2400 A)	Not specified (1-20 A) ±1.0° (20-200 A) ±0.5° (200-3600 A)	±1° (5-3000 A, 45 Hz to 66 Hz) ±4° (200 A, 40 Hz to 1 kHz)
Maximum allowable current (600 Hz or less)	1200 Arms AC (continuous)	2400 Arms AC (continuous)	2400-2800 Arms AC (for 15 minutes) 2800-3600 Arms AC (for 10 minutes)	3600 Arms AC (10 Hz to 1 kHz)	360 Arms AC
Output impedance	2 Ω or less			Approx. 47 Ω	
External magnetic field effects	±0.1% of full scale (at 400 A/m, 50/60 Hz)			±0.1% of full scale (at 400 A/m, 50/60 Hz)	
Conductor position effects	1% ±0.2 A or less			±2% of full scale	
Operating circuit voltage	600 Vrms AC max.			Main unit: 600 Vrms AC max. Measuring unit: 1000 Vrms AC max.	
Measurable conductor diameter	ø64 × 100 mm, five 125 × 5 mm bus bars, or three 100 × 10 mm bus bars			ø170 mm max.	
External dimensions	Approx. 310 (W) × 120 (H) × 48 (D) mm			Main unit: Approx. 140 (W) × 64 (H) × 28 (D) mm Measuring unit: Approx. 610 mm	
Weight	Approx. 1400 g			Main unit: Approx. 300 g (including battery and output cable) Measuring unit: Approx. 180 g	
Output cable length	Approx. 3 meters			Approx. 3 meters	
Output terminal	Banana plug (safety terminal)			Banana plug (safety terminal)	
Power supply				9 V alkaline battery (6LF22) AC Adapter Continuous measurement: 150 hours Intermittent measurement: 10,000 times	

## Power monitors/POWERCERT



- For site management : PR201/UZ005
- For centralized management : UPM Series

**YOKOGAWA**   
Yokogawa M&C Corporation

World Wide Web site at  
<http://www.yokogawa.com/MCC>

### NOTICE

- Before using the product, read the instruction manual carefully to ensure proper and safe operation

YOKOGAWA M&C CORPORATION International Sales Dept. 2-9-32 Nakacho, Musashino-shi, Tokyo, 180-8750 Japan  
Phone: +81-422-52-5716 Facsimile: +81-422-55-8954

YOKOGAWA CORPORATION OF AMERICA  
2 Dart Road, Newnan, GA 30265-1094 U.S.A.  
Phone: +1-770-253-7000 Facsimile: +1-770-251-2088

YOKOGAWA EUROPE B. V.  
Databankweg 20, 3821 AL Amersfoort, THE NETHERLANDS  
Phone: +31-334-64-1611 Facsimile: +31-334-64-1610

YOKOGAWA ENGINEERING ASIA PTE. LTD.  
5 Bedok South Road, Singapore 469270 SINGAPORE  
Phone: +65-6241-9933 Facsimile: +65-6241-2606

YOKOGAWA AMERICA DO SUL LTDA.  
Praça Acapulco, 31-Santo Amaro, Sao Paulo/SP, BRAZIL CEP-04675-190  
Phone: +55-11-5681-2400  
Facsimile: +55-11-5681-1274/4434

YOKOGAWA MEASURING INSTRUMENTS KOREA CORPORATION  
City Air Terminal Bldg., 405-9, #159-6, Samsung-dong, Kangnam-ku, Seoul, 135-728 KOREA  
Phone: +82-2-551-0660 Facsimile: +82-2-551-0665

YOKOGAWA AUSTRALIA PTY. LTD.  
CentreCourt D1, 25-27 Paul Street North, North Ryde, N.S.W. 2113, AUSTRALIA  
Phone: +61-2-9805-0699 Facsimile: +61-2-9888-1844

YOKOGAWA BLUE STAR LTD.  
40/4 Lavelle Road, Bangalore, 560 001 INDIA  
Phone: +91-80-227-1513 Facsimile: +91-80-227-4270

YOKOGAWA MIDDLE EAST E.C.  
P.O. BOX 10070, Manama, Building 577, Road 2516, Busaiten 225, Muharraq, BAHRAIN  
Phone: +973-358100 Facsimile: +973-336100

LTD. YOKOGAWA ELECTRIC  
Grokhol'skiy per. 13, Build. 2, 4th Floor, 129090, Moscow  
RUSSIAN FEDERATION  
Phone: +7-095-737-7868 Facsimile: +7-095-737-7869

Represented by:

MCK-EM10