

YOKOGAWA 

DL1700E Series

DL1720E/DL1740E/DL1740EL
Digital Oscilloscopes



Signal Explorer

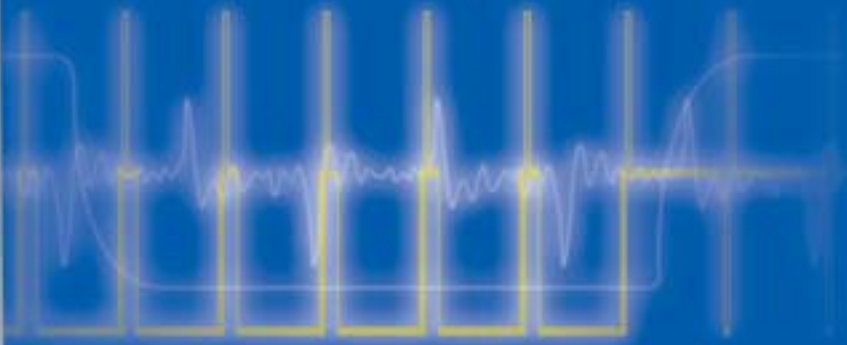

DL1740EL

- Up to 1 GS/s, 8 MW Memory
- 500 MHz Analog Bandwidth
- PC Card Interface
- USB Storage
- I²C & SPI Bus Trigger and Analysis

1 GS/s
Max. Sampling Rate

8 MW
Max. Memory



Bulletin 7017-40E

Switch

Three New Models are Here! Longer Memory and Enhanced Features



- **Maximum Sampling Rate**
1GS/s: Real-time sampling
100GS/s: Repetitive sampling
- **Bandwidth**
500MHz
- **Maximum Record Length **New****
DL1740EL: **8 Mwords (8 times longer ¹)**
DL1740E: **2 Mwords (2 times longer ¹)**
DL1720E: 1 Mword
1. When compared with the previous model of the DL1740
- **PC Card Interface (Type II) **New****
(or select floppy disk for removable media type)
- **USB Storage and USB Peripherals **New****
Supports USB memory devices (flash memory, hard disk drive, MO drive, etc.)
Supports a USB mouse, keyboard, or printer
- **Built-In Printer** (Optional)
- **Ethernet Function** (Optional) **New**
Web Server, FTP server, and network printing
- **I²C and SPI Bus Trigger and Analysis** (Optional) **New**
- **HDTV Trigger **New****

DL1700E Series Lineup

Model	DL1720E	DL1740E	DL1740EL
Item	701715	701730	701740
Analog input channels	2	4	4
Max. Sampling rate	1GS/s		
Bandwidth	500MHz		
Max. Record length	1MW/ch	2MW/ch	8MW/ch

Easily and Accurately Capture Increasingly Complex Signals

Accurately Capture and Observe Waveforms with the 8 Mword Long Memory and Easy Zoom Function

Even some oscilloscopes with high sampling rates may not be able to accurately capture waveforms if the memory size is not large enough for the required monitoring period. This limitation is due to the necessary drop in sampling rate, which occurs if the recording memory is not long enough. A larger recording memory not only increases the monitoring time, but also enables users to maintain a high sampling rate thus ensuring accurate waveform representation. In addition, the zoom function can be used to simultaneously view enlarged images on one or two segments of a waveform captured in the large memory.

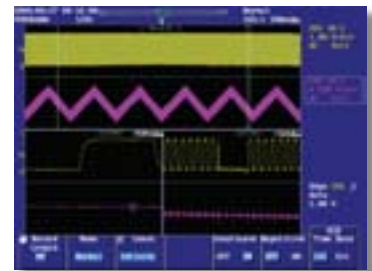
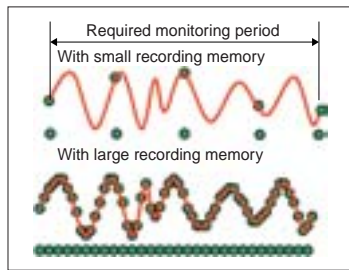

All-Points Display and Fast Screen Updates Make Sure You Won't Miss Abnormal Signals

When working with data captured in the large recording memory, the amount of information appearing on the display varies greatly depending on how the data are presented. The differences occur depending on whether you choose to display all points in a captured waveform, or just major values, such as maximum and minimum values, in a given segment of the waveform. The DL1700E Series provides fast screen updating in all-points display mode, so you won't miss abnormal phenomena or have slow responses to instrument controls.

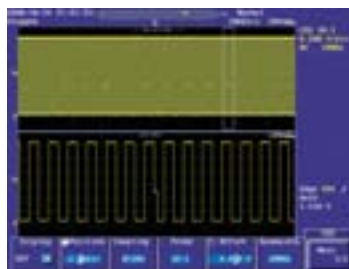

All-points display



Conventional compression display

Easily Find and Display Desired Data from Large Amounts of Data

Smart Search Function for Effective Access to the Data You Need

"I want to find the serial data with a particular serial pattern", "I need to search for surge pulses of less than 30 ns", "I want to only extract waveforms that occasionally overshoot by an excessive amount".....As data volume increases, it becomes more important to be able to search for target phenomena efficiently. The Smart Search function automatically detects serial patterns, pulse widths, rising edges, falling edges, and other phenomena in the captured waveform data. These phenomena are then displayed in the zoom screen. Smart Search will significantly improve the efficiency of your development and evaluation work.



Serial pattern search setup

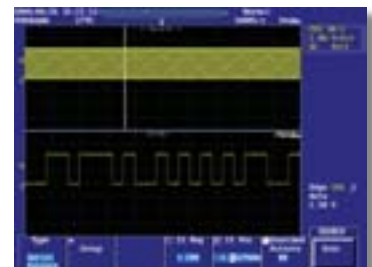

Serial pattern search results

When an abnormal signal is displayed on the screen, does it disappear before you can press the STOP key?

History Memory

The history memory function divides the large recording memory into a number of blocks and automatically saves up to 2048 previously captured waveforms. Increase the number of screens saved to history memory by setting a shorter record length.



History Search

The history search function is useful for quickly finding abnormal waveforms in the large amounts of waveform data stored in history memory. This function lets you automatically search for desired waveforms based on whether or not a signal passes through a user-defined area on the screen. You can also conduct searches based on waveform parameters.

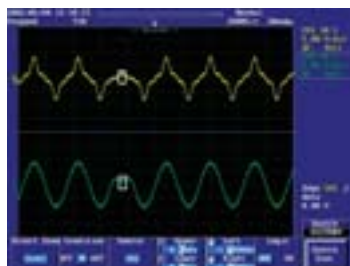

History Statistics

Calculates statistical information based on the parameter values for waveforms stored in history memory. This function calculates and displays a parameter's maximum value, minimum value, average value, and standard deviation. You can check the parameters for every waveform in history memory.

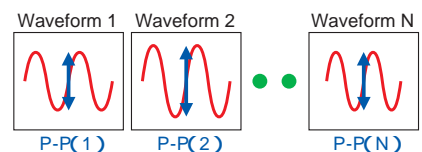

Waveform Parameter List	
P-P(1)	P-P(2)
0.00000	0.00000
0.00000	0.00000
0.00000	0.00000
0.00000	0.00000
0.00000	0.00000
0.00000	0.00000
0.00000	0.00000
0.00000	0.00000
0.00000	0.00000
0.00000	0.00000

A Variety of Functions Offer the Best Solutions for Diverse Measurement Needs

Measuring Periodically Fluctuating Amplitudes

Cycle Statistics

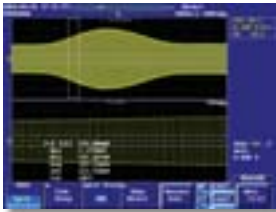

Automatically calculates the maximum value, minimum value, average value, and standard deviation of selected waveform parameters for each period of a signal. You can even find the period corresponding to the calculated maximum and minimum values and display that period in the zoom window. In some applications, like with a PWM (pulse width

modulation) control signal, you may need to determine information about each waveform period for long amounts of time. The DL1700E Series with its long memory, lets you analyze a long waveform, period-by-period, based on the period of a reference signal.

How can I quickly count a large number of pulses in a waveform?

Pulse Count

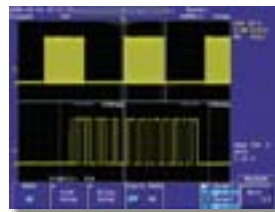

Automatically counts the number of pulses in the waveform data between cursors. The threshold level for recognizing a single pulse is user-definable, so you can reliably compute pulses even in signals with unstable levels. With the DL1700E Series, you'll never again have to manually count pulses on screen or on a stack of printouts.

Envelope and Roll modes for simultaneously observing both slow and fast signals

Envelope mode always captures signals at the highest sampling rate, irrespective of the time-axis setting. This mode is effective when observing high-frequency noise superposed on a slow signal. Roll mode allows you to observe signals on the screen in much the same way as you record them on a chart recorder. When in normal mode, you can set the sampling rate as high as 2 MS/s for roll mode. In addition, you can have a roll-mode view of signals in the envelope mode.

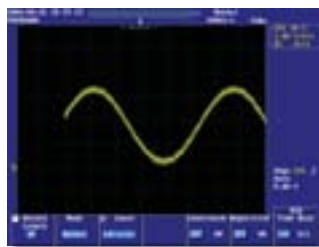

Roll-mode View in Normal Mode

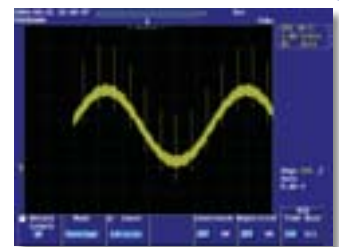

Roll-mode View in Envelope Mode

Simple and Enhanced Triggers for Reliable Capturing of a Variety of Waveforms

Simple and Enhanced Triggers

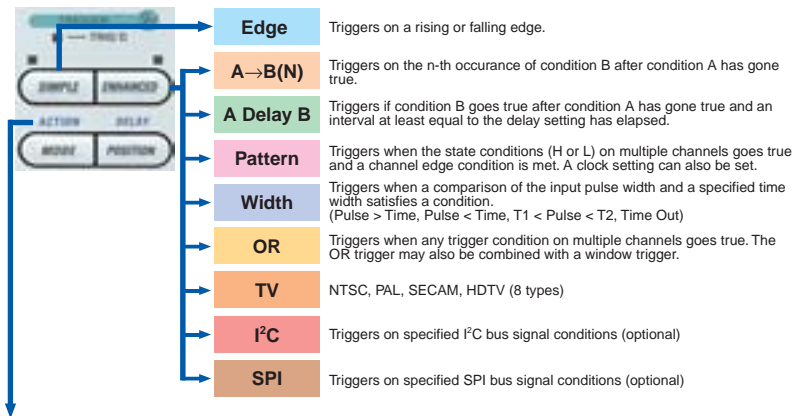

Action-On Trigger

With the action-on trigger, a specified action is automatically executed each time the trigger is activated. You can use the trigger for a variety of actions, such as automatically saving captured data. The action-on trigger is useful for purposes such as collecting data in continuous tests.

GO/NO GO Judgment

— Automatic Waveform Discrimination —



Select zones or parameters for the waveform of an acquired signal. The DL1700E judges the signal being measured and automatically takes action. Actions you can choose from include: outputting screen images data to the destination specified in the Copy Setup menu, saving waveform data in the medium specified in the File menu, sounding the buzzer, and sending e-mail.

Dedicated I²C Bus Trigger and Analysis Function (Optional)

I²C bus signals (SCL and SDA) used extensively in home electronics such as televisions and video cameras and in communications equipment such as mobile phones can be captured with specialized triggers, analyzed, and displayed as waveforms.

I²C Bus Analysis Function

Triggers can be activated using conditions such as Start, Non-Ack, Address pattern, and Data pattern. These dedicated I²C bus triggers can also be combined with other analog signals to activate additional triggers.



I²C bus trigger setup menu

I²C Bus Analysis Function

Captured waveforms can be analyzed in a time series manner, and the analysis results displayed in a list.

When an analysis result is selected with the cursor, the corresponding waveform is automatically enlarged in the zoom area. Two pairs of I²C busses can be input at the same time, then analysis can be performed alternately on either bus.



I²C bus analysis results

Dedicated SPI Bus Trigger and Analysis Function (Optional)

The SPI data bus is a synchronous 8-bit serial bus used widely for inter-IC and data communications in embedded systems. SPI bus signals can be captured using the DL1700E dedicated triggers and the waveforms can be analyzed and displayed on the screen.

SPI Bus Trigger Function

Triggers can be activated by comparing each byte of MOSI (master output slave input) and MISO (master input slave output) data with specified conditions. You can trigger on user-defined strings of data from 1 to 8 bytes long.

SPI Bus Analysis Function

Data analysis results and SS (slave select) bits can be displayed in a list together with the waveforms. You can perform a high speed search for a specified MOSI or MISO data pattern (of 1 to 8 bytes) from within all of the captured data.



SPI bus analysis setting screen

Connection with a Wide Range of Peripherals such as PC, Printer

USB

Peripheral Device Connections

- USB compatible flash memory, hard drives, or MO drives can be connected to easily save waveform data and screen images.
- The DL1700E Series can be completely controlled using a USB mouse.
- File names can be entered using a USB keyboard.
- Connect a USB printer for color printouts.



PC Connection

- You can create a PC program to remotely control the DL1700E via USB. This is similar to how you would control operations via GP-IB.

Ethernet

Web Server

With an Ethernet connection, you can perform various functions using Internet Explorer.

• FTP

Easily copy and paste files from the DL1700E's internal storage devices to connected PC or network drive. The internal storage device functions as one of your PC file servers.



• Data Capture

Perform actions such as waveform monitoring, uploading settings, and starting/stopping measurements.



• Measurement Trend

Automatically opens Excel, then periodically downloads waveform parameter values and graphs them. Easily monitor parameter trends during extended-period measurements.



• Printing on a Network Printer

The screen image can be printed on a network printer in the same way as you would print to the internal printer or a USB printer.



Easily and Quickly Output Images and Data to a Full Range of Output Devices

The COPY key lets you print screenshots to the built-in printer, a USB printer, or a network printer.



By simply pressing IMAGE SAVE key, you can easily and quickly save screen image data to the PC card, USB flash memory, MO, or hard disk media. You can select a data format of BMP, TIFF, PS, PNG, or JPEG. Thumbnail images make previewing your captured images simple. The thumbnail appears together with the file name, allowing you to confirm, delete, or make spot changes to the image file name.



Rear Panel

USB-PC Connector

Compliant with USB Rev. 1.1

USB Peripheral Connectors

Type A connectors: 2
Compliant with USB Rev. 1.1
Accepts a USB flash memory device, hard drive, MO drive, mouse, keyboard, or printer.

External Trigger Input/External Clock Input/Trigger Gate Input (701715 is on the front panel)

Inputs DC to 100 MHz signal for external triggering (external trigger input).
Inputs clock signal from 40 Hz to 20 MHz from exterior (external clock).
Trigger occurrence can be controlled using external signal (trigger gate input).

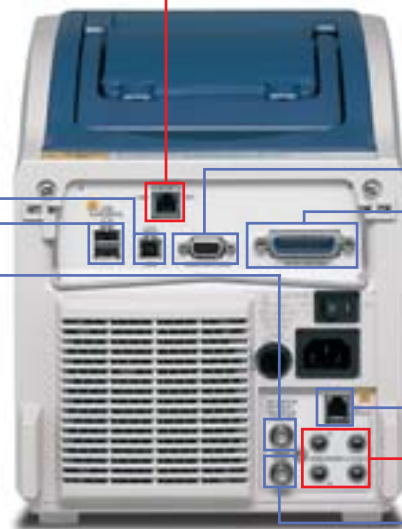

Ethernet (Optional)

100 BASE-TX/10-BASE-T compliant
Lets you take advantage of Web Server and WebDAV functions.

RGB Video Signal Output Connector

Outputs a video signal for viewing waveforms on an external monitor.

GP-IB

GO/NO-GO Output Terminal

Using the GO/NO-GO function, you can output waveform judgment results as TTL level signals.

Probe Power Terminal (Optional)

(Two outputs on the 701715)

Power output terminals for accessory probes.

Trigger Output

Outputs TTL level trigger signal.

Software

Remotely Control the DL Series Using a PC

Wirepuller (Free Software)



The Wirepuller software program displays a screen image of the DL's front panel on your PC for monitoring waveform signals. You control the DL by simply using your PC's mouse and keyboard to perform actions on the displayed front panel.

Interface: USB/GP-IB/Ethernet
Supported operating systems: Windows 95/98/2000/Me/NT 4.0 or higher/XP

See Yokogawa's homepage for further details.

This software is free and can be downloaded from the following URL: <http://www.yokogawa.com/tm/wirepuller/>

View Waveform Data on Your PC

Waveform Viewer for DL Series (700919)



Waveform Viewer lets you view waveforms on your PC, just as you view them on the DL's screen. In addition to zoom windows, you can also use X-Y display, and history memory thumbnail displays. Data can be converted to CSV format for use in programs like Excel.

Data transfer: Floppy disk/Type II PC Card/USB/GP-IB/Ethernet
Supported operating systems: Windows 95/98/2000/Me/NT 4.0 or higher/XP

See Yokogawa's homepage for further details.

A trial version of this program can be downloaded from the following URL: <http://www.yokogawa.com/tm/700919/>

Accessories



900 MHz FET probe (700939)
Attenuation ratio: 1/10 with 50 Ω load
Input voltage range: ±10 V



50 MHz current probe (700937)
Input range: 15 Arms



100 MHz current probe (701932)
Input range: 30 Arms



10 MHz current probe (701930)
Input range: 150 Arms



100 MHz differential probe (701924)
Attenuation ratio: Can be switched between 1/100 and 1/1000
Max. differential allowed voltage: ±350 V/(1/100), ±1400 V/(1/1000)



100 MHz differential probe (701921)
Attenuation ratio: Can be switched between 1/10 and 1/100
Max. differential allowed voltage: ±70 V/(1/10), ±700 V/(1/100)



200 MHz differential probe (701922)
Attenuation ratio: 1/10 with 50 Ω load
Max. differential allowed voltage: ±20 V



500 MHz differential probe (701920)
Attenuation ratio: 1/10 with 50 Ω load
Max. differential allowed voltage: ±12 V

Main Specifications

Basic Specifications

Input channels	4 (701730, 701740) 2 (701715)
Input coupling	AC 1 M Ω , DC 1 M Ω , DC 50 Ω , GND
Input impedance	1 M Ω ±1.0%, 50 Ω ±1.0%
Voltage axis sensitivity setting	Range For 1 M Ω input: 2 mV/div to 10 V/div (steps of 1, 2, or 5) For 50 Ω input: 2 mV/div to 1 V/div (steps of 1, 2, or 5)
Maximum input voltage	For 1 M Ω input (frequency of 1 kHz or less): 400 V (DC + ACpeak)(282 Vrms CAT II) For 50 Ω input: 5 Vrms or 10 Vpeak (and neither are exceeded)
Frequency characteristics ¹	For 1 M Ω input (using passive probe model 700988; specified at probe tip): 10 V/div to 10 mV/div: DC to 400 MHz 5 mV/div to 2 mV/div: DC to 300 MHz For 50 Ω input: 1 V/div to 10 mV/div: DC to 500 MHz 5 mV/div to 2 mV/div: DC to 400 MHz
A/D conversion resolution	8 bits (24 LSB/div)
Maximum sampling rate	Real-time sampling mode Interleave mode ON: 1 GS/s ² Interleave mode OFF: 500 MS/s Repetitive sampling mode: 100 GS/s
Maximum record length	701715 Interleave mode ON: 1 MW/CH ² Interleave mode OFF: 500 kW/CH 701730 Interleave mode ON: 2 MW/CH ² Interleave mode OFF: 1 MW/CH 701740 Interleave mode ON: 8 MW/CH ² Interleave mode OFF: 4 MW/CH
DC accuracy ¹	±(1.5% of 8 div + offset voltage accuracy)
Offset voltage axis accuracy ¹	2 mV/div to 50 mV/div: ±(1% of setting + 0.2 mV) 100 mV/div to 500 mV/div: ±(1% of setting + 2 mV) 1 V/div to 10 V/div: ±(1% of setting + 20 mV)
Time axis setting range	1 ns/div to 50 s/div (for record length of 10 kW or greater) 1 ns/div to 5 s/div (for record length of 1 kW)
Time base accuracy ¹	±0.005%
External clock input	Input frequency range: 40 Hz to 20 MHz (continuous clock signal only)

Trigger

Trigger modes	Auto, Auto Level, Normal, Single, Single (N)
Trigger source	CH1 to CH4 (or CH1 to CH2 for the 701715), LINE (connected commercial power signal), EXT (signal input from the EXT TRIG IN terminal)
Trigger types	Edge, A->B(N), A Delay B, OR, Pattern, Pulse width, TV, I ² C (optional), SPI (optional)

Display

Screen updating rate	Maximum 60 times per second (for 10 kW all-points display) Maximum 30 times per second (for 1 MW all-points display)
Display	6.4-inch color TFT liquid crystal display

* Note that an LCD may contain some pixels which always glow or never glow or may have uneven brightness due to its characteristics. These are not indications of an equipment problem.

Functions

• Vertical/Horizontal Axis Setting

Input filter	Band limit of 100 MHz or 20 MHz can be set independently on each channel (CH1 to CH4, or CH1 to CH2 for the 701715)
Roll mode	The roll display mode is enabled when the trigger mode is auto, auto level, or single and the time axis is as follows: For record lengths of 1 MW or less: 50 ms/div-50 s/div (or 50 ms/div-50 s/div in the case of 1 kW only) For a record length of 2 MW: 100 ms/div-50 s/div For a record length of 4 MW: 200 ms/div-50 s/div For a record length of 8 MW: 500 ms/div-50 s/div

• Waveform Acquisition/Display Functions

Acquisition modes	Normal, Envelope, Averaging, Box Average
Zoom	Zoom in on displayed waveforms along the time axis (one or two zoom windows with separate enlargement ratios)
X-Y display	Two X-Y waveform displays are available, XY1 and XY2 (only XY1 is available on the 701715).

• Analysis Function

Search and Zoom function	Edge, serial pattern, parallel pattern, pulse width, auto scroll, I ² C (optional), SPI (optional)
History search functions	Zone, parameter
Cursor measurements	Horizontal, Vertical, Marker, Degree
Automatic Measurement of	Waveform Parameters Function P-P, Max, Min, Avg, Rms, Sdev, High, Low, +OShot, -OShot, Int1TY, Int2TY, Int1XY, Int2XY, Freq, Period, Rise, Fall, +Width, -Width, Duty, Burst1, Burst2, Pulse, AvgFreq, AvgPeriod, Delay (between channels) Also, the following statistical processes can be performed Source items: The above parameters Statistics: Min, Max, Avg, Cnt, Sdv Statistical mode: Normal, Cycle, History
Computation Functions	+, -, x, binary computation, inversion, differentiation, integration, power spectrum (FFT)

GO/NO-GO judgment	Evaluation based on automatically measured waveform parameter values and waveform zones
-------------------	---

• Output Screen Image Data

Built-in printer (optional)	Paper width: 112 mm Output formats: Normal, Long
External printer	Outputs to an external printer via the USB PERIPHERAL terminal or Ethernet ³ . Supports the following printer formats: ESC/P, ESC/P2, LIPS3, PCL5, BJ, PostScript (via Ethernet only ³)
Floppy disk / PC card / Network Drive (via Ethernet ³ / USB Storage)	Output data formats: PostScript, TIFF, BMP, JPEG, PNG

I²C Bus Analysis Function (Option for the DL1740E and DL1740EL)

• Applicable Bus	I ² C bus	Bus transfer rate: Up to 3.4 Mbit/s Address mode: 7 bit System Management Bus compliant
SM bus		
• Trigger Function	Trigger source	CH1: SCL CH2: SDA CH3, CH4: Analog signal input Triggers on Start conditions Trigger on user-defined address Triggers on user-defined data byte immediately after address Up to 9,999 can be specified Triggers on user-defined data byte after byte count has elapsed, up to 2 bytes can be specified Triggers when no acknowledgment is given Analog signals on CH3 and CH4 can be combined with the I ² C bus trigger.
Start Condition		
Address		
Data 1		
Byte Count		
Data 2		
Non-ACK trigger		
Combination trigger		
• Analysis Functions	Waveform & data display	Simultaneous display of data (hex display) and waveforms Time from a reference point, data (simultaneous display in binary and hex), and presence or absence of ACK
Detailed data display		
Number of analyzable data		Up to 40,000 bytes worth (20,000 bytes before and after the reference point)
Analysis channels		SCL: CH1, CH3 SDA: CH2, CH4 Enables switching of analysis between two pairs of busses

SPI Bus Analysis Function (Option for the DL1740E, DL1740EL)

• Trigger Functions	Trigger source	CH1: SCK CH2: MOSI CH3: MISO CH4: SS
Assertion of SS	A Pattern	Triggers on SS assertion Triggers on user-defined MOSI data directly after SS assertion, up to 8 bytes can be specified Up to 1,000 times can be specified Triggers on user-defined data after byte count has elapsed, up to 8 bytes can be specified
Byte Count	B Pattern	
• Analysis Function	Waveform & data display	Simultaneous display of data (hex display) and waveforms Time from a reference point, data (binary or hex), and CS signal condition
Detailed data display		
Number of analyzable data		Up to 80,000 bytes worth (40,000 bytes before and after the reference point)
Analysis channels		CH1: Clock signal (SCK) CH2: Data1 (MOSI) CH3: Data2 (MISO) CH4: CS signal (SS)

Rear Panel I/O Section

USB PERIPHERAL Interface	Compliant with USB Rev. 1.1 Accepts a USB compatible flash memory device, hard drive, MO drive, mouse, keyboard, or printer.
Computer interface	GP-IB, USB-PC connector (USB Rev 1.1 compliant), Ethernet (100BASE-TX/10BASE-T compliant, optional)
Signal I/O	External trigger input/external clock input/trigger gate input, trigger output, RGB video signal output (VGA), GO/NO-GO output
Probe power terminal (optional)	No. of terminals: 4 (701730, 701740) 2 (701715) Output voltage: ±12 V

General Specifications

Rated supply voltage	100-120 VAC/220-240VAC (switches automatically)
Rated supply frequency	50/60 Hz
Maximum power consumption	200 VA
External dimensions	220 mm (W) × 265.8 mm (H) × 264.1 mm (D) (when the printer cover is closed; does not include handle and protrusions)
Weight	Approximately 5.5 kg (with all options) Approximately 5.4 kg (without options)
Operating temperature range	5-40°C

1: Measured value under standard operating conditions (below) after warming up the instrument, performing calibration, and setting the time base to internal clock.

Standard operating conditions Ambient temperature: 23 ±2°C
Ambient humidity: Humidity: 55 ±10% RH

2: When Interleave mode is ON, the number of available channels is reduced by half.

3: With the /C10 option

The specifications can be viewed at the following URL. <http://www.yokogawa.com/tm/DL1700E/>

DL1720E, DL1740E, DL1740EL Model Number and Suffix Codes

Model	Suffix Code	Description
701715		DL1720E digital oscilloscope with 2 ch input and maximum 1 MW memory
701730		DL1740E digital oscilloscope with 4 ch input and maximum 2 MW memory
701740		DL1740EL digital oscilloscope with 4 ch input and maximum 8 MW memory
Power cable	-D	UL and CSA standard
	-F	VDE standard
	-Q	BS standard
	-R	AS standard
	-H	GB standard
Internal storage drive	-J1	Floppy disk drive ¹
	-J3	PC card interface (type II) ¹
Options	/B5	Built-in printer
	/P2	Probe power for model 701715 ²
	/P4	Probe power for models 701730 and 701740 ²
	/C10	Ethernet interface
	/F5	I ² C + SPI bus analysis function ³

The instrument comes standard with passive probes (700988). Four probes are included with the 701730 and 701740, and two probes are included with the 701715.

1. One or the other must be selected.

2. Select /P2 for model 701715, or /P4 for models 701730 and 701740.

3. Option for models 701730 and 701740 only.

Standard Accessories

Name	Quantity
Power cable	1
Passive probe (700988)	1 per channel
Power fuse	1
Front cover (transparent type)	1
Soft case for probe	1
Printer roll paper (when the /B5 option is specified)	1
User's manual (one set)	1

Supplies

Name	Part number	Description	Order Quantity
Printer roll paper	B9850NX	30 meter roll (1 roll per package)	5
Passive probe	700988	10 M Ω (10:1), 400 MHz band, 1.5 m (1 probe per package)	1
Front cover	B9989FA	LCD, protects front panel	1

Related Products



[Signal Explorer is a registered trademark of Yokogawa Electric Corporation.]

Microsoft, MS, Windows, and Internet Explorer are trademarks or registered trademarks of Microsoft Corporation in the US and other countries.

Microdrive is a trademark or registered trademark of International Business Machines Corporation in the US and other countries.

Ethernet is a registered trademark of Xerox Corporation.

Zip is a trademark or registered trademark of Iomega Corporation in the US and other countries.

Other company names and product names appearing in this document are trademarks or registered trademarks of their respective companies.

Accessories (Optional)

Name	Model	Description
FET probe	700939	900 MHz
100:1 probe	700978	100 MHz
Current probe	700937	DC to 50 MHz, 15 Arms
Current probe	701932	DC to 100 MHz, 30 Arms
Current probe	701930	DC to 10 MHz, 150 Arms
Current probe	701931	DC to 2 MHz, 500 Arms
Differential probe	700925	DC to 15 MHz
Differential probe	700924	DC to 100 MHz
Differential probe	701921	DC to 100 MHz
Differential probe	701922	DC to 200 MHz
Differential probe	701920	DC to 500 MHz

Exterior Dimensions

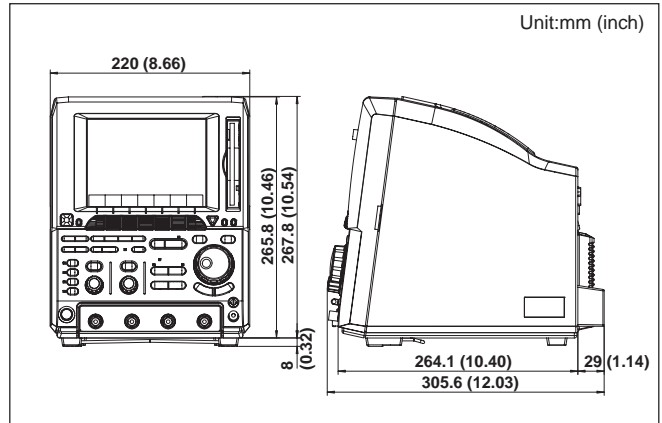

YOKOGAWA

YOKOGAWA ELECTRIC CORPORATION

Test and Measurement Business Div./Phone: (81)-55-243-0313, Fax: (81)-55-243-0396

E-mail: tm@csv.yokogawa.co.jp

YOKOGAWA CORPORATION OF AMERICA

YOKOGAWA EUROPE B.V.

YOKOGAWA ENGINEERING ASIA PTE. LTD

Phone: (1)-770-253-7000, Fax: (1)-770-251-2088

Phone: (31)-33-4641806, Fax: (31)-33-4641807

Phone: (65)-62419933, Fax: (65)-62412606

Subject to change without notice.

[Ed : 01/b] Copyright ©2004

Printed in Japan, 406(KP)