



M O D E L P F X 2 5 1 1



For Battery Test System

Charge/Discharge System Controller PFX2511

Maximum Voltage:60.0000V /Maximum Current:50.0000A

- Capable of high-precision measurement of cumulative capacities and amount of power as well as voltage and current.
 - Supports temperature measurement and capable of monitoring temperatures during charging/discharging.
- Employs full safety features of the overcharge protection using voltage, electric charge and temperature.

For evaluation of secondary batteries !

Solution for battery test achieved with our DC power supply and electronic load!!

System configuration (example)▶

The example system configuration consists of the charge/discharge system controller "PFX2511", the DC power supply "PWR800L", and the Electronic load "PLZ1004W". The dimension of the system may differ depends on the configuration of the selected models. (the PC show in the picture is not included.) The PFX2121 (communication control unit) is also required.

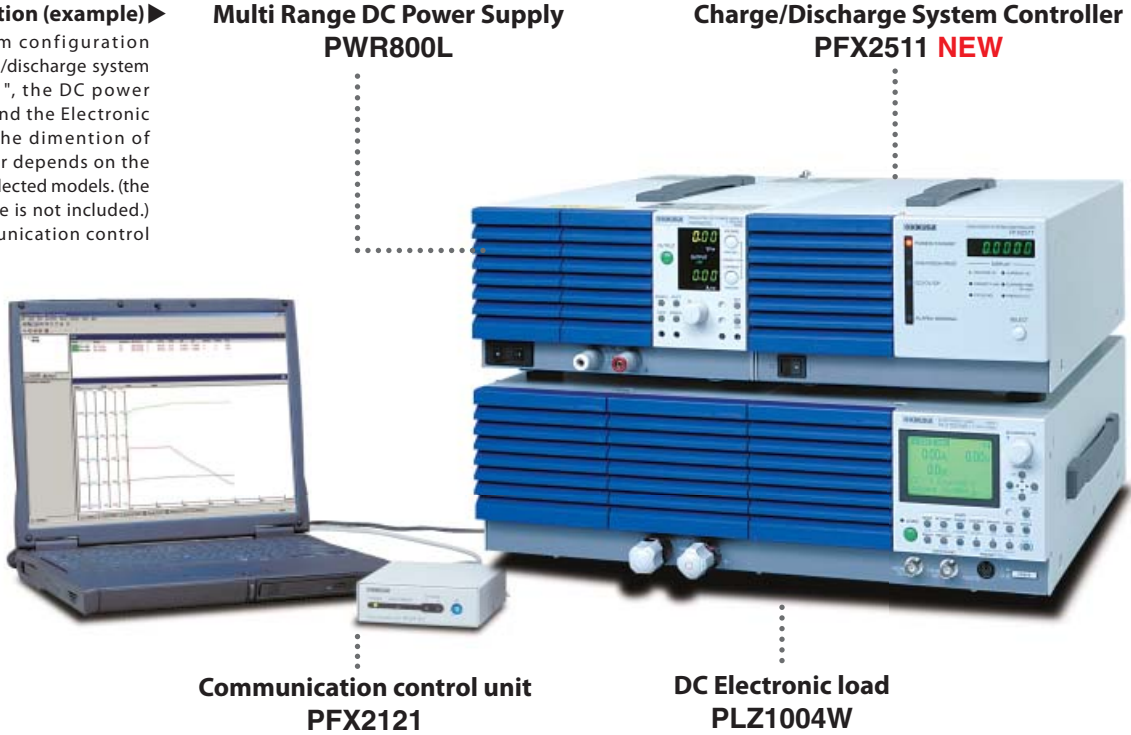

Charge/Discharge test system can be configured for up to 60V and 50A

PFX2511 is a high performance Charge/Discharge system controller that takes measurements in combination with our DC power supply and electronic load.

In recent years, voltage (number of stacks) and capacity (Ah value) of secondary batteries have become varied, and support for such diversity is required of characteristic evaluations and test equipment. However, the general-purpose test equipment supports measurements and evaluations of large-capacity batteries. We were left with no choice but prepare a DC power supply, electronic load, digital multi-meter, recorder, temperature measuring device and such equipment and order a custom-designed system to control them or make it on our own (while worrying about the reliability).

Based on our abundant experience with battery evaluation systems, we have packed PFX2511 with our technology of Charge/Discharge control and high-precision measurement required for electronic characteristic evaluation of batteries. If you already have our power supply and electronic load, you can easily configure a high-precision battery test system.



- The system for charge and discharge testing can be configured with the selected Kikusui's electronic load and the DC power supply.
- The applicable maximum voltage:60.0000 V/The applicable maximum current:50.0000 A
- Charge mode: (CC-CV, CC)
- Discharge mode: (CC, CP, CC Pulse, CP pulse)
- Equipped with an electric input/output terminal, load switch (route switch circuit)
- Supports temperature measurement
- Equipped with the vibration sensor (auto stop function) .
- Included the application software
Application software "BPChecker2000 Basic edition (Up to 2CH)"

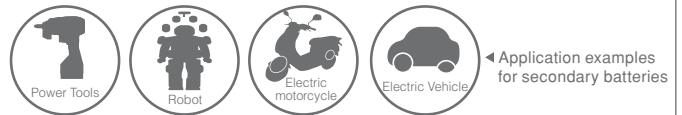

Charge/Discharge System Controller

PFX2511



Features/Functions

Flexible configuration of the system achieved with the conventional power supply and electronic load

PFX2511 is used as a charge and discharge test system combined with the selected DC power supply (charging) and electronic load (discharging). This allows flexible configuration of the system.

● System configuration diagram

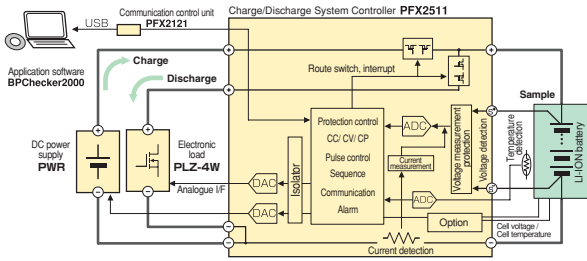

Easy configuration: The selected equipment can be assigned for the system!

It is possible to configure the system by yourself. All the parts required for connection can be purchased from us. The DC power supply and electronic load that are applied configuration with PFX2511, can be used for the system. This allows you to have a test system at low cost.

*For details, please refer to the list of applied configuration and options on page 7.

Adopting the digital control of the constant current (CC) and constant voltage (CV)

The digital CC and CV control method is adopted to minimize the difference between the setting accuracy and the drift characteristic of constant current (CC) /constant voltage (CV) generated from the system configuration of the DC power supply and the electronic load, and it can apply for the precise evaluation. Any of the adjustment are not required after the system configuration.

Protection functions for safety operation

Several protective functions are required to improve the safety of charge and discharge test of secondary batteries. PFX2511 is equipped with protection functions provided by hardware and software against phenomena such as overcharge and overdischarge. The route switch (load switch) is built in the PFX2511 and it equips with a function to ensure connection between the DUT (batteries) and the DC power supply/electronic load as well as a high-speed interruption function that promptly disconnects the DC power supply / electronic load in case any abnormal state is detected. In addition, the vibration sensor detects major vibration and shock in case of a disaster or accident during charge and discharge test, then shuts off the output, and it prevents a damage to the connected equipment and the DUT (batteries).

Precise measurement

The high-precision measurement circuit is equipped in the PFX2511. It detects the battery voltage and the charge and discharge current in high accuracy. (Measurement resolutions: 100 μ V and 100 μ A, Elapsed time measurement: within 10 ppm)

Pulse discharge function

It allows discharge test that simulates a change of dynamic load current in cellular phones, digital cameras, laptop computers, etc. Capacity calculation is performed with the actual measurements from the pulse current, and the maximum and minimum voltages in the cycle are also measured.

Capable of complex control of charge and discharge

The unit can perform complex control of charge and discharge required for testing (controls time and measurement of voltage, current, temperature, capacity and power). Even when controlling remotely, a change of the display with the switches on the front panel allows you to view and check the details of the test.

Protection function for the DUT cable connection

It detects such as an incomplete connection of the DUT, an abnormality of wirings, the potential difference when it exceeds a regulated value of the DUT cable and the voltage sensing line, and it protects connecting equipment and the DUT (battery) from being damaged.

Typical graph of Charge Mode Operation

CC-CV (constant current-constant voltage)

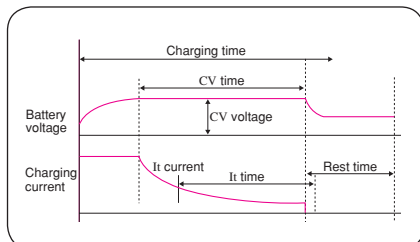

[Termination conditions] Time, CV time, current, and temperature

CC (constant current)

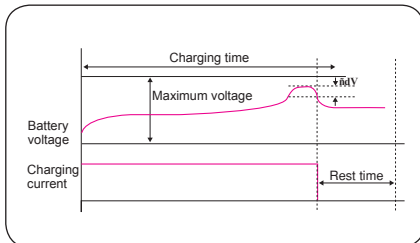

[Termination conditions] Time, voltage, $-\Delta V$, temperature, and $\Delta T/\Delta t$

Typical graph of Discharge Mode Operation

CC (constant current)

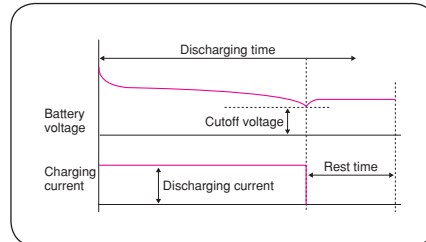

[Termination conditions] Time and voltage

CP (constant power)

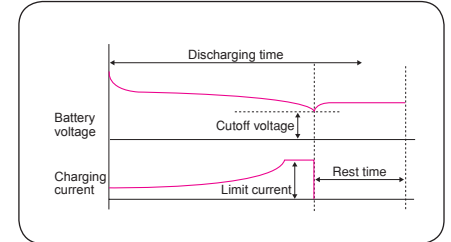

[Termination conditions] Time and voltage

20-value CC pulse (Constant current pulse)

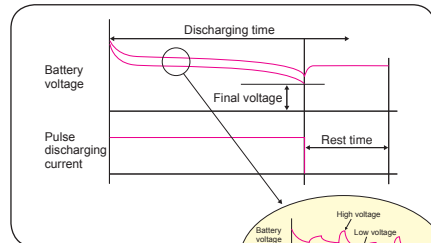

[Termination conditions] Time and low voltage

20-value CP pulse (constant power pulse)

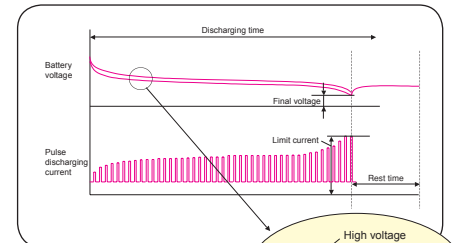

[Termination conditions] Time and low voltage

Application Software

The exclusive application software **BPChecker2000 Basic** is capable of management from the setting and execution of the test condition file to the analysis of the test result.

The application software, BPChecker2000, can manage all processes from creating the test condition file to output of the test result file. Setting and execution of conditions for battery charge and discharge characteristics test and an analysis of test results can be performed on the PC. In addition, if the PC is equipped with GPIB communication environment, it can externally control the temperature chambers manufactured by ESPEC, and it allows to synchronize with the temperatures in the chamber.

* The control of BPChecker2000 Basic supplied with PFX2511 is limited to 2 channels. BPChecker2000 Full Edition with no function limit is sold separately.

* For the control of temperature chamber, it is recommended to use a RS232C for the PC side, a RS485 for the temperature chamber, and the ERC-200C(ESPEC) for the converter. (See page 6)

● **Program Structure** This software consists of five programs. (Test Condition Editor, Graph Viewer, Test Executive, Hardware Config Wizard, Group Administrator.)The following describes three of the main features.

Test Condition Editor

This program is used to create and edit all test conditions related to charge/discharge testing. A total of 20 sheets of test condition data can be created, with each sheet specifying both charge and discharge conditions. It is also possible to set the number of times (repeats) that an individual sheet is to be repeated to form a particular charge/discharge cycle, as well as the repeated number of (loops) the entire sheets can be set.

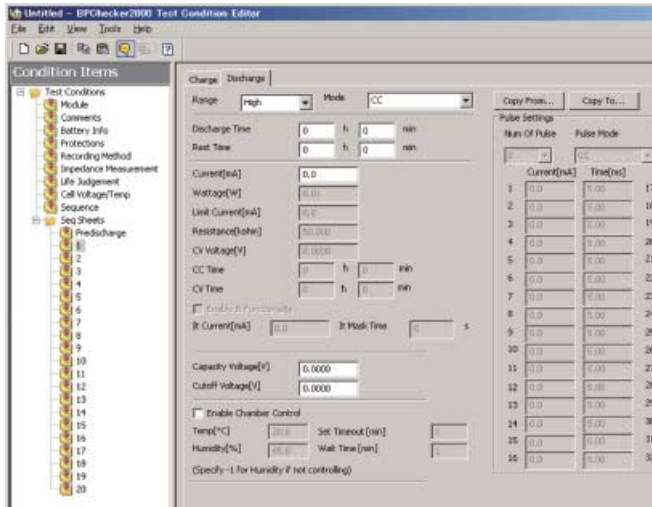
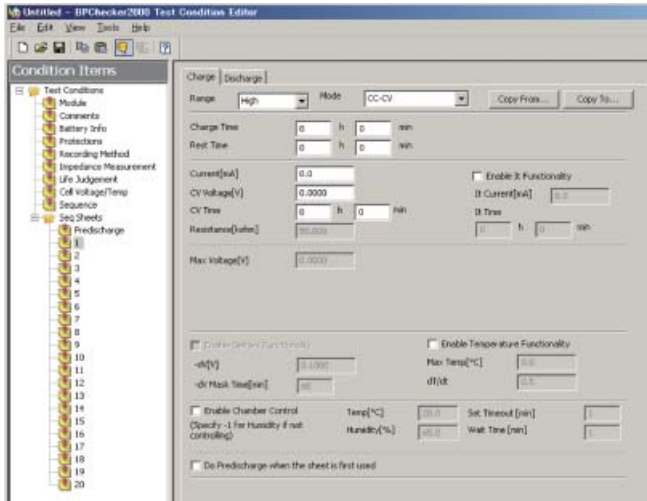

[Recommended Operating Environment]

- CPU: Pentium IV 1 GHz or faster
- OS: Windows XP (SP2 or later, x86), Vista (x86, x64), 7(x86, x64)
- Memory: 512 MB or more
- HD drive: 50 MB of free space or more required for installation; 10 GB of free space or more recommended for data
- CD-ROM drive: Required for installing the applications
- Mouse: Required
- Display resolution: 1024 x 768 or more
- Printer: Compatible with Windows
- No. of USB ports: More free USB ports than the number of control units to be used
- The thermostatic chambers that can be controlled via Espec Corp.'s protocol converter/RS485-RS232C converter.
- VISA library: NI-VISA 3.3 or later, Agilent I/O Libraries Suite 15.0 or later, or KI-VISA 3.1.3 or later

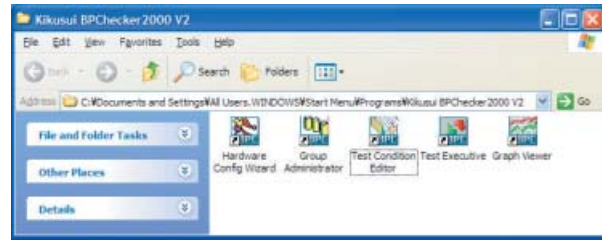

Graph Viewer

This program is used to display the graph of test data on the screen and print the graph. It offers a graphic representation of the charge/discharge data of each cycle. You can display up to 99 sets of data to superimpose the graph of each other and perform statistical processing.

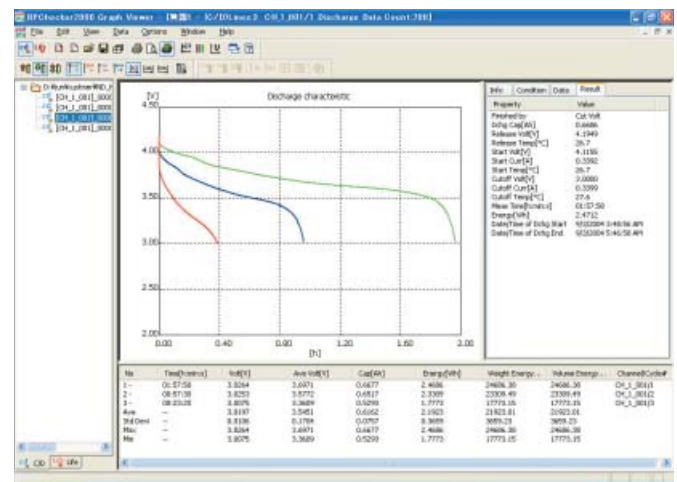

Test Executive

This program executes charge/discharge tests according to the test condition file created using the Test Condition Editor. It starts and stops the test and monitors the test execution. The program provides a real-time graphic representation of the per-channel charge/discharge trends.

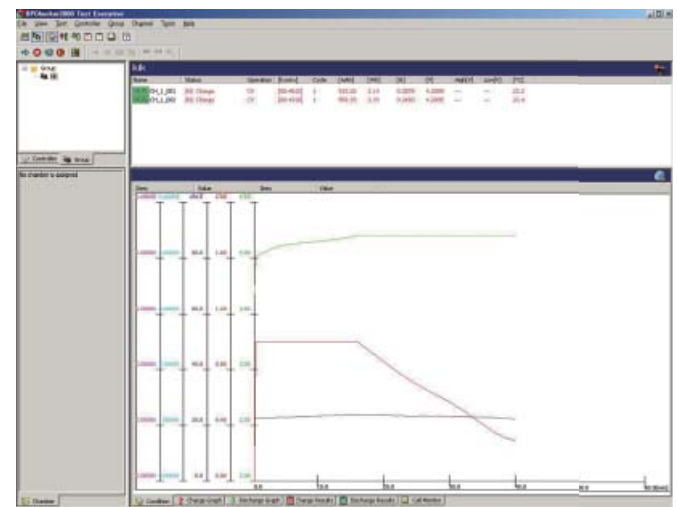

Typical Applications

Test sample data taken by the application software BPChecker2000

Discharge Rate Characteristics Test

Test to observe characteristics with varying load conditions under constant charge condition and discharge temperature.

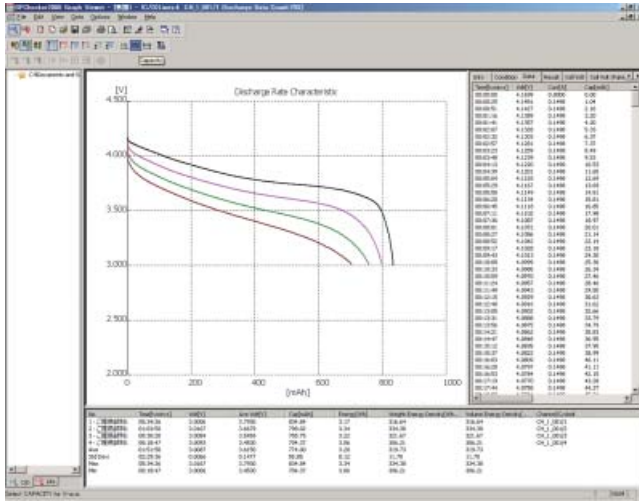

Discharge Temperature Characteristics Test

Test to observe characteristics with varying discharge temperatures under constant charge condition and discharge current.

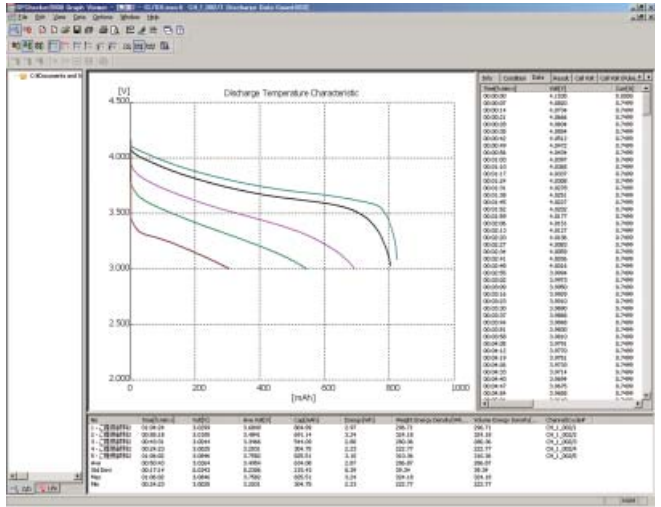

Cycle Life Test

Test to observe capacity deterioration in repeated cycles under constant charge and discharge conditions.

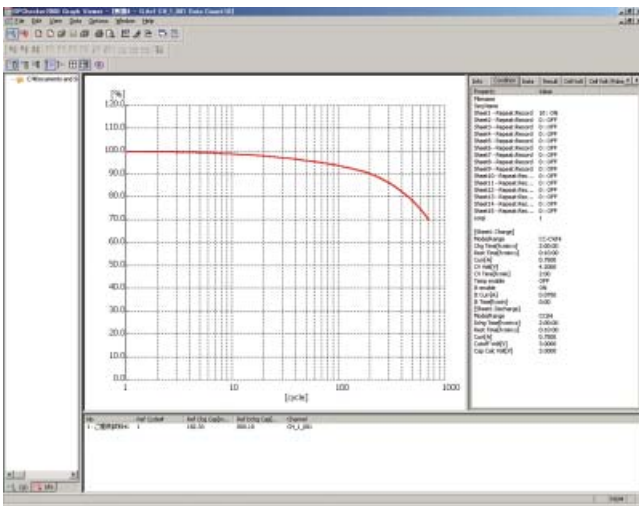

Pulse Discharge Test

Discharge characteristics similar to the actual load environment can be obtained using the pulse discharge mode.

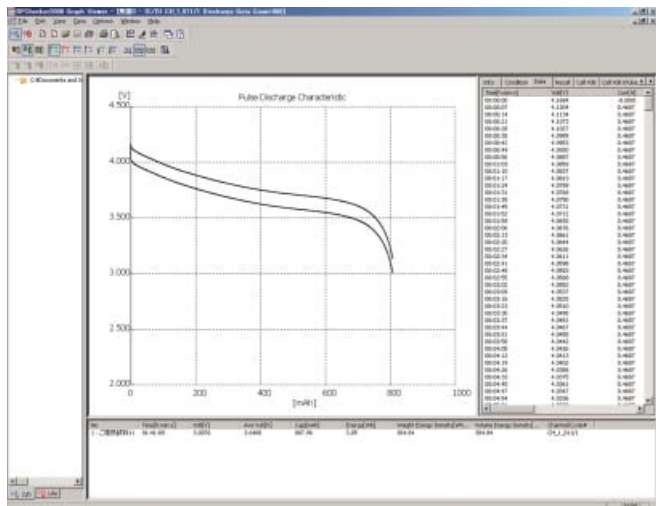

Report Output

Plotted images can be printed out by Graph Viewer.



Copy & Paste to Excel and PowerPoint

The plotted graphs and numerical data can be pasted to other application software such as Excel and PowerPoint.

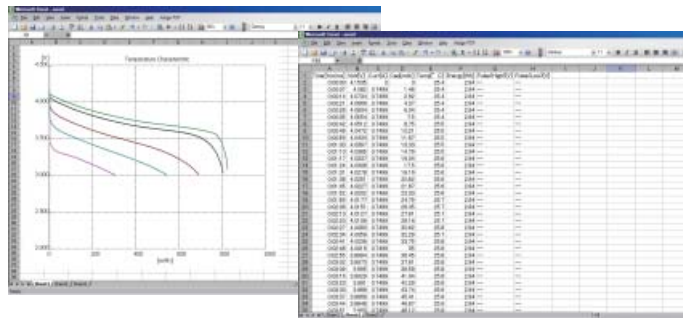

Example of Excel display

System Configuration

[System Configuration example]

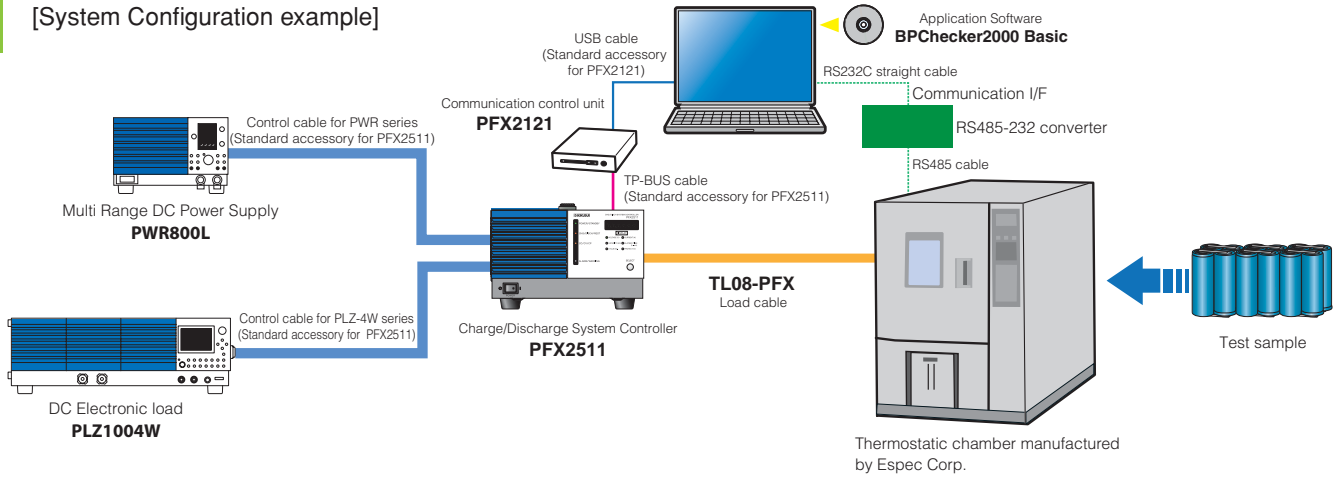

- Multi Range DC Power Supply: PWR800L
- DC Electronic load: PLZ1004W
- Charge/Discharge System Controller: PFX2511
- Communication control unit: PFX2121
- Application Software: BPChecker2000Basic.(Standard accessory)
- Load cable(50A, 5m): TL08-PFX
- Personal computer.....Windows XP or later. Display resolution: 1024 x 768 or more
- Thermostatic chamber..... PFX2511 supports synchronized operation with temperature chambers. To perform synchronized operation, temperature chambers equipped with a communication function, manufactured by ESPEC and the associated components are required. For details, please consult with us.

Voltage/thermometer unit (optional)

When monitoring the status of each cell of the battery pack is required, install the optional voltage/thermometer unit OP01-PFX. One board of OP01-PFX allows monitoring and logging of voltages and temperatures for 4 cells. (Up to 3 boards can be installed.) For a battery pack connected in series, monitoring of balance among cells is important. With OP01-PFX, the charge and discharge control can be stopped according to the status of each cell. In addition, it is equipped with a function to stop charge and discharge when the balance between the cells in the battery pack becomes large (maximum voltage - minimum voltage). Furthermore, at the time of pulse discharge, voltage can be measured at the same time as the synchronization of all cells for load fluctuations.



Voltage/thermometer unit
[OP01-PFX]
Lead wire for OP01-PFX
[TL09-PFX]

Charge and discharge system controller for large capacity (200A)

For larger capacity more than 50A, charge and discharge controllers that can support up to 200A are available.

- Maximum voltage 60V, maximum current 100A
- Maximum voltage 60V, maximum current 200A



Rack mount System We also provide a rack mounting service.

- System rack: KRC363L
- * The picture shown below is an example of the rack mount system

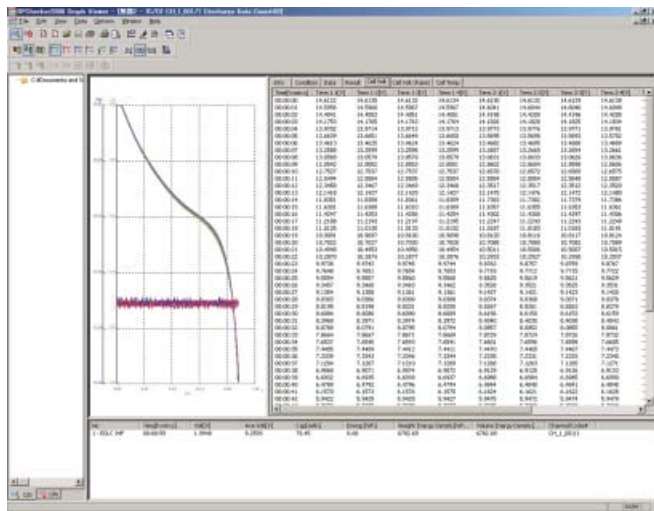

Note: Version of SD002 (BP checker 2000) must be ver.3.0 or above.

Expanded features

- Monitor data: Cell voltage, cell temperature, cell high voltage* and cell low voltage*
- Charge stop conditions: Cell voltage, cell temperature and potential difference among cells
- Discharge stop conditions: Cell voltage and potential difference among cells
- Protective functions: Cell voltage, cell temperature and potential difference among cells

*Pulse discharge only

Restricted functions

The maximum number of channels that 1 unit of personal computer can control is 5 ch.

The system with PFX2511

● Applied configuration (model ID)

Model IDs are used for combinations of the selected power supply and electronic load. If you wish to have a combination without a verified model ID, please consult with us. More Model IDs will be added in future.

Model ID	Power supply for charge	Electronic load for discharge
5101 (M range)	PWR800L	PLZ1004W
5102 (H range)	PWR800L	PLZ1004W
5103	PWR1600L	PLZ1004Wx2
5104	PWR800L	PLZ334W
5106	PWR1600L	PLZ1004W
5107	PAS10-70	PLZ1004W

Model ID	Power supply for charge	Electronic load for discharge
5108	PAS20-36	PLZ1004W
5109	PAS20-54	PLZ1004W
5110	PAS40-27	PLZ1004W
5111	PWR800L	PLZ164W
5112	PAS10-35	PLZ334W

[As of the end of February, 2010]

● Note on selecting power supply for charge (route loss)

Application of the charge current causes a voltage drop in the DUT cable, connecting cables, the current pass route of the PFX2511, etc. The power loss at charging caused by this voltage drop is the route loss. The maximum power that can be used for charging is the value from which the route loss is subtracted.

[Maximum charge power = Maximum rated power of DC power supply - Route loss]

● Note on selecting electronic load for discharge (minimum operating voltage for discharge)

The electronic load has minimum operating voltage (1.5V in PLZ1004W), and it does not operate at the voltage below the specified level. The result of an addition of this level and the route loss (voltage drop) is the minimum operating voltage for discharge. [Minimum operating voltage for discharge = Minimum operating voltage of electronic load + Voltage drop caused by route loss]

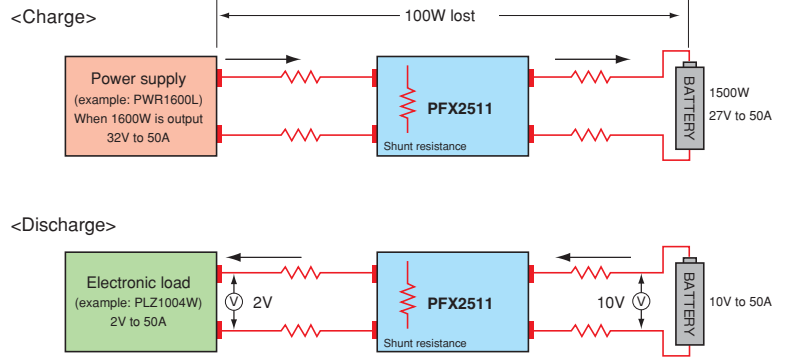

The list of compatible models for combination shown below uses the test load (TL08-PFX) instead of the rated outputs, and shows the estimated outputs at the battery terminal when used with the maximum current.

[Conceptual diagram of route loss]



● List of the applied configuration with PFX2511

* If you wish to have a combination other than the models below, please contact with us.

Power supply for charging	Estimated output			Input	Remark	Appearance
	Voltage(V)	Current(A)	Power limit (W)			
PWR400L	0 to 60	0 to 25	350	AC100/200V 6.5/3.3A	Wide range DC power supply Constant power type power supply with wide variable ranges of voltage and current. One unit serves as multiple units of a single range DC power supply.	 PWR Series
PWR800L	0 to 60	0 to 50	700	AC100/200V 13/6.5A		
PWR1600L	0 to 60	0 to 50	1400	AC100/200V 26/13A		
Electronic load for discharging	Estimated output			Input	Remark	Appearance
	Voltage(V)	Current(A)	Power limit (W)			
PLZ164W	6 to 60	0 to 33	165	AC90 to 250V 80VA	By adding a bias power supply, the minimum discharge voltage can be lowered. For details, please contact with us.	 PLZ-4W Series
PLZ334W	8 to 60	0 to 50	330	AC90 to 250V 90VA		
PLZ1004W	8 to 60	0 to 50	1000	AC90 to 250V 90VA		
PLZ2004WB	8 to 60	0 to 50	2000	AC90 to 250V 200VA		
PLZ164WA	4.5 to 60	0 to 33	165	AC90 to 250V 450VA		
PLZ664WA	4.5 to 60	0 to 50	660	AC90 to 250V 1500VA		

[As of the end of February, 2010]

● Options

Model name	Description	Reference
PFX2121	Charge/Discharge System Controller	
TL08-PFX	Load cable(with voltage current, and temperatur sensing cable.)	Supplied with sensing cable. Heat resistant up to 105°C
SD002	Application Software BPChecker2000 Full Edition	The 2-channel version is supplied with PFX2511
OP01-PFX	4-cell voltage / Thermometer unit	Up to 3 boards can be mounted
TL09-PFX	Voltage lead wire for OP01-PFX for 4 cells, K type thermocouple for 4 cells	Heat resistant up to 105°C

[As of the end of February, 2010]

Specifications

PFX2511 is a digital power controller that provides feedback of the setting from measured values at high speed. The setting accuracy depends on the measurement accuracy.

The following specifies the measurement accuracy.

■ Charge/discharge system controller PFX2511 Electrical Specifications

Measurement Accuracy		Static	
Charge / discharge Current measurement	Range	0.0000A to 50.0000A	
	Accuracy ^{*1,2}	± (0.15% of rdng +0.02% of f.s)	
	Resolution	0.1mA	
Voltage measurement	Range	-6.0000V to 60.0000V	
	Accuracy ^{*1,2}	± (0.05% of rdng +0.02% of f.s)	
	Resolution	0.1mV	
Capacity calculation	Range	0.0000Ah to 2000.0000Ah	
	Accuracy ^{*1,2}	Rely on the current measuring accuracy and the time accuracy	
	Resolution	0.1mAh	
Time ^{*3}	Accuracy ^{*1,4}	±10ppm (TYP values)	
Pulse			
Charge / discharge current	Range	0.0000A to 50.0000A	
	Accuracy ^{*1,2}	± (0.2% of rdng +0.03% of f.s)	
	Resolution	0.1mA	
	Measured value	Average current, Update a data per period of 500 ms	
Battery voltage	Range	0.0000V to 60.0000V	
	Accuracy ^{*1,2}	± (0.05% of rdng +0.02% of f.s)	
	Resolution	0.1mV	
	Measurement point	High voltage	Indicates the maximum battery voltage in one cycle of the pulse setting.
Low voltage		Indicates the maximum battery voltage in one cycle of the pulse setting.	
Arbitrary		At the specified pulse point	
Capacity calculation	Range	0.0000Ah to 2000.0000Ah	
	Accuracy ^{*1,2}	Rely on the current measuring accuracy and the time accuracy	
	Resolution	0.1mAh	
Time ^{*3}	Accuracy ^{*1,4}	±10ppm (TYP values)	
Temperature measurement			
Temperature sensing element	thermistor (103AT-2, Ishizuka denshi)		
Measurable range	-40.0 °C to 100.0 °C		
Measurement resolution	0.1 °C		
Measurement accuracy	±0.5 °C (Measuring temperature at 0 °C to 40.0 °C)		
	±1 °C (Measuring temperature at -20 °C to 80 °C)		

*1: Ambient temperature at 18 °C to 28 °C.

*2: Measurement range : within the above specified range

*3: Accuracy of the elapsed time (terminate condition) under the discharging state, resting state.

*4: Approx. 30s. of the monthly error

● General Specifications

Input voltage range 90Vac to 250Vac

Power consumption 60VAmx

Weight Approx. 7 kg (15.43 lb)

[Accessories]

Application Software (BP Checker2000 Basic Editon(CD-ROM)), Power cord : 1 pc.
Cable with crimp terminal : 4 pcs. (Red : 2 pcs., White: 2 pcs. 45 cm each (17.72 inch)), 26-core flat cable : 1 pc., 20-core flat cable : 1 pc., Twisted-pair wire with TP-BUS connectors : 1 pc. (1 m (39.37 inch)), TP-BUS core : 1 pc., Sensing connector : 1 pc., Thermistor : 1 pc., Lock lever : 2 pc., Operation manual : 1 copy, BPChecker 2000 setup guide : 1 copy

* Load cable (TL08-PFX) is not included. It is sold separately.

* For rack mounting, the rack adapter KRA3 (inch) or KRA150 (millimeter) is required.

■ Voltage/thermometer unit OP01-PFX

Cell Voltage measurement		Static	
Number of measurement terminals	4		
Measurable range ^{*1}	-2.0000V to 20.0000V		
Accuracy	±(0.05% of rdng +0.02% of f.s)		
Measurement resolution ^{*2}	0.1 mV		
Measurement value	Average voltage of the every 500ms		
Measurement interval	500 ms		
Pulse			
Number of measurement terminals	4		
Measurable range ^{*1}	-2.0000V to 20.0000V		
Accuracy	±(0.05% of rdng +0.02% of f.s)		
Measurement resolution ^{*2}	0.1mV		
Measurement value ^{*3}	High voltage	Maximum voltage in one cycle	
	Low voltage	Maximum voltage in one cycle	
	user-specified	-	
Measurement interval ^{*4}	1 ms		

*1: You can apply a voltage from -20V to 22V.

*2: Ambient temperature at 18°C to 28°C

*3: Automatically synchronized with the PFX2511 pulse setting (specify two points from high voltage, low voltage, and user-specified).

*4: The application software records data every second.

Cell Temperature measurement ^{*1}		Static	
Number of measurement terminals	4		
Thermocouple type	K type		
Measurable range ^{*2}	-100.0°C to 400.0°C		
Measurement resolution ^{*3,4}	±1.5°C (TYP values)		
Reference junction compensation ^{*5}	±0.5°C(TYP values)		
Accuracy	0.1°C		

*1: The temperature scale conforms to JIS C 1602-1995(ITS-90)(ITS-90 is an international temperature scale.)

*2: Depending on your thermocouple's specifications(wire diameter and insulation), the usable temperature range will vary.

*3: Ambient temperature at 18°C to 28°C.

*4: When the voltage that the thermocouple's calibrator produces is measured(the thermocouple tolerance is not included)

*5: This shows the internal sensor performance.

It indicates the temperature measurement accuracy of the thermocouple connector.

Thermometer accuracy= Measurement accuracy + reference junction compensation + thermocouple tolerance

■ Outline Drawing

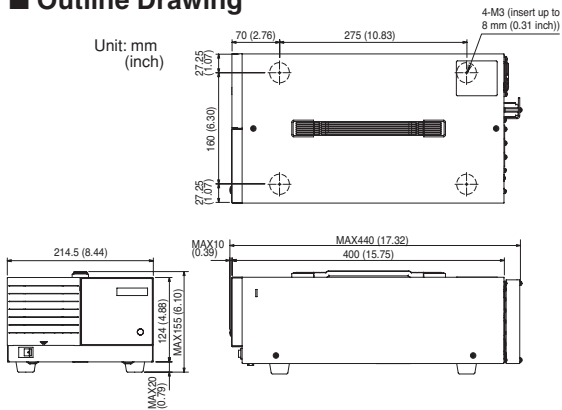

● Distributor:



KIKUSUI ELECTRONICS CORPORATION

1-1-3, Higashiyamata, Tsuzuki-ku, Yokohama, 224-0023, Japan

Phone: (+81) 45-593-7570, Facsimile: (+81) 45-593-7571, www.kikusui.co.jp

KIKUSUI AMERICA, INC. 1-877-876-2807 www.kikusuiamerica.com



1633 Bayshore Highway, Suite 331, Burlingame, CA 94010
Phone : 650-259-5900 Facsimile : 650-259-5904

KIKUSUI TRADING (SHANGHAI) Co., Ltd. www.kikusui.cn



Room, D-01,11F, Majesty Bld, No.138, Pudong Ave, Shanghai City
Phone : 021-5887-9067 Facsimile : 021-5887-9069

For our local sales distributors and representatives, please refer to "sales network" of our website.

■ All products contained in this catalogue are equipment and devices that are premised on use under the supervision of qualified personnel, and are not designed or produced for home-use or use by general consumers. ■ Specifications, design and so forth are subject to change without prior notice to improve the quality. ■ Product names and prices are subject to change and production may be discontinued when necessary. ■ Product names, company names and brand names contained in this catalogue represent the respective registered trade name or trade mark. ■ Colors, textures and so forth of photographs shown in this catalogue may differ from actual products due to a limited fidelity in printing. ■ Although every effort has been made to provide the information as accurate as possible for this catalogue, certain details have unavoidably been omitted due to limitations in space. ■ If you find any misprints or errors in this catalogue, it would be appreciated if you would inform us. ■ Please contact our distributors to confirm specifications, price, accessories or anything that may be unclear when placing an order or concluding a purchasing agreement.

Printed in Japan

Issue: Apr.2010

201004pdf EC21a